



Review of Low Carbon Technologies for Heavy Goods Vehicles – Annex 1

Prepared for Department for Transport

RD.09/182601.7

June 2009

Authors:

Hannah Baker
Richard Cornwell
Enrico Koehler
Jane Patterson

Approved:

A handwritten signature in black ink that reads 'N. N. Powell'.

Nick Powell, Manager Technology and Clean Energy

- **Feasibility Analysis**

HGVs have been divided into medium and heavy duty for feasibility analysis to allow for the differences in typical vehicle operation

- For the purpose of feasibility analysis of low carbon technologies to HGVs, vehicles have been divided into medium duty and heavy duty, which allows for the differences in vehicle operation
- These vehicle types were agreed with DfT at the inception meeting

Medium Duty



- Most common vehicle in the UK is 7.5t 2-axle rigid with a box van type body
- Typical operation tends to be in an urban environment involving frequent stop – start events

Heavy Duty



- Typically an articulated vehicle, comprising a tractor and trailer with a GVW >32.5 tonnes utilising a three axle configuration
- Typical operation is long motorway journeys at constant speed with little urban driving

A typical medium duty vehicle in the UK is a 7.5t 2-axle rigid, which operates over a predominantly urban cycle with frequent stopping



- Average medium duty truck in the UK is a 7.5t 2-axle rigid, which operates over a predominantly urban drive cycle
- Vehicles are mainly diesel powered with manual transmissions, with AMTs and automatics offered as options

Medium Duty Vehicle Drive Cycle

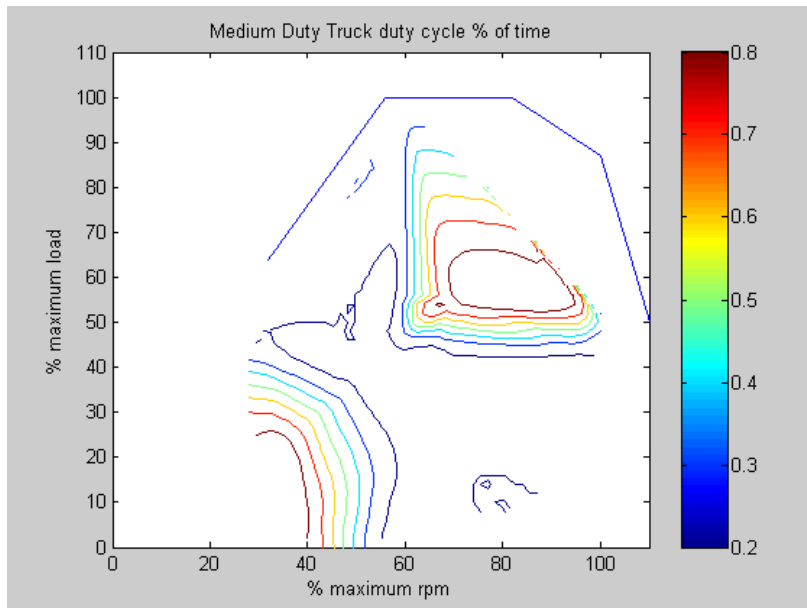

Medium Duty New Vehicle Benchmark

Fuel	Diesel
Engine Capacity (litres)	4.4
Power (kW)	132
Engine Technology	DOHC, L4, DI-CR, TCI, SCR
Fuel Consumption (l/100km)	20.6
Emissions Class	Euro 4
Transmission	Manual 6 (Optional AMT 6 / Auto 5)
Fuel Tank Capacity (litres)	119
AdBlue Tank Capacity (litres)	24
GVW (kg)	7,500
GCW (kg)	11,000
Payload (kg)	4,202
Wheelbase (m)	4
Cab Type	Day

A typical heavy duty vehicle in the UK is a 40t articulated vehicle in a 3-axle configuration used for long haul goods distribution



- A typical heavy duty vehicle in the UK is a 40t articulated vehicle in a 3-axle configuration used for long haul goods distribution
- Vehicles are mainly diesel powered with manual splitter transmissions, with AMTs offered as options

Heavy Duty Vehicle Drive Cycle

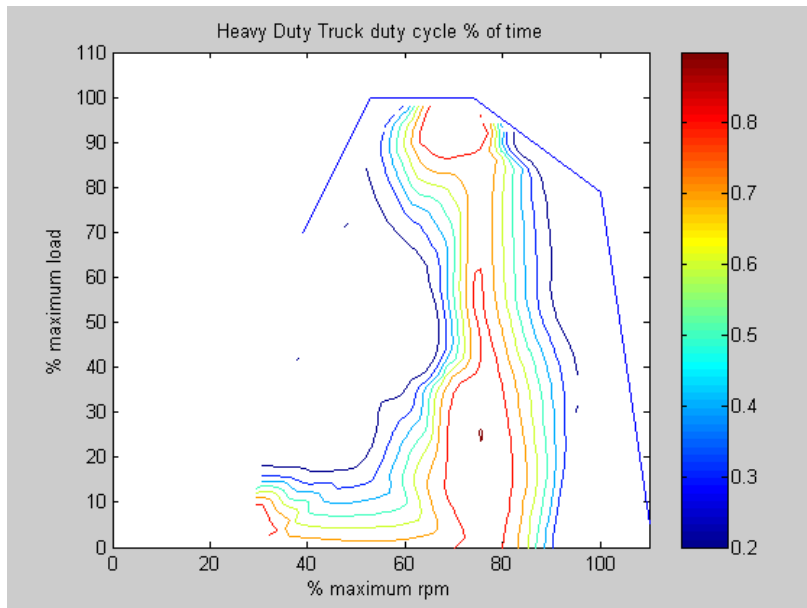

Heavy Duty New Vehicle Benchmark

Fuel	Diesel
Engine Capacity (litres)	11.6
Power (kW)	326
Engine Technology	DOHC, L6, DI-UI, TCI, SCR
Fuel Consumption (l/100km)	35.7
Emissions Class	Euro 4/5
Transmission	Manual 14/16 Splitter (Optional AMT)
Fuel Tank Capacity (litres)	450
AdBlue Tank Capacity (litres)	68
GVW (kg)	18,000
GCW (kg)	40,000
Payload (kg)	11,201
Wheelbase (m)	3.7
Cab Type	Sleeper

To ensure a good understanding of the potential of each technology a common rating system was employed (1/3)



- For each technology considered, the impact of the technology in terms of CO₂ benefit, technology and environmental cost, safety and limitations and technology maturity has been rated from 1 to 10
- The description of these ratings is as follows:

CO₂ Benefit

- 1 = Worst = no CO₂ benefit
 - 2 = 1% CO₂ benefit
 - 5 = 5% CO₂ benefit
 - 8 = 10% CO₂ benefit
 - 10 = Best = 30% CO₂ benefit
-
- CO₂ benefit is given considering tailpipe CO₂ on a per-vehicle basis only. No consideration has been given of fleet mix of vehicle types. With the exception of biofuels, no consideration of lifecycle CO₂ has been possible within the scope of this project

To ensure a good understanding of the potential of each technology a common rating system was employed (2/3)



Technology Cost

- 1 = Worst = 100% additional on-cost relative to incumbent technology (vehicle, powertrain or fuel), not whole vehicle
 - 3 = ~ 50% on-cost
 - 5 = ~ 10% on-cost
 - 7 = ~5% on-cost
 - 9 = ~2% on-cost
 - 10 = Best = no additional on-cost
- Technology cost considers the additional on-cost of the technology over the incumbent technology and generally does not take into account any lifecycle costs such as maintenance and fuel savings

Environmental Cost

- 1 = Worst = Technology will cause significant damage to the environment during production and disposal
 - 3 = Life-cycle environmental impact expected to be worse than incumbent technology
 - 5 = Neutral – new technology no better and no worse than incumbent technology
 - 8 = Life-cycle environmental impact expected to be better than incumbent technology
 - 10 = Best = Life-cycle environmental impact expected to be significantly less than incumbent technology
- Environmental costs make a subjective assessment of the environmental impact of the technology taking into account any different manufacturing processes or materials used which may lead to increased CO₂ emissions during manufacture and whether the technology has benefits of reducing emissions other than CO₂
- No full lifecycle assessment has been conducted

To ensure a good understanding of the potential of each technology a common rating system was employed (3/3)



Safety and Limitations

- 1 = Worst = DO NOT USE this technology
 - 2 = Several major safety issues need to be addressed / Several limitations restrict areas of application
 - 3 = A few safety issues that need to be addressed / a few limitations restricting application areas
 - 5 = No new safety issues, but a few limitations
 - 6 = No additional safety concerns or limitations with using this technology
 - 7 = No new safety issues, and fewer limitations / more advantages in using the new technology
 - 9 = More advantages than disadvantages, and it's safer
 - 10 = Best = this technology is much safer to use than the incumbent technology and has far fewer limitations
-
- Safety and limitations considers any safety issues that may be associated with a new technology whether to a person maintaining or operating the vehicle or potential damage to the vehicle and captures, where applicable, any adverse impacts on engine/vehicle durability
 - It also covers restrictions that may occur on vehicle usage and loading due to the new technology and issues associated with the introduction of the technology to market

Technology Maturity

- 1 = University Research Laboratory
- 3 = Technology available but not in HGVs
- 4 = First Prototype in HGVs
- 6 = In Fleet Trials
- 7 = First entry into market
- 10 = Predominant technology in market place

- **Feasibility Analysis**
 - **Vehicle Technologies**
 - Powertrain Technologies
 - Fuel Technologies

Rolling resistance and aerodynamic drag represent the largest areas of energy consumption and are the areas targeted for improvement



Energy Distribution for HGV, 44t GVW

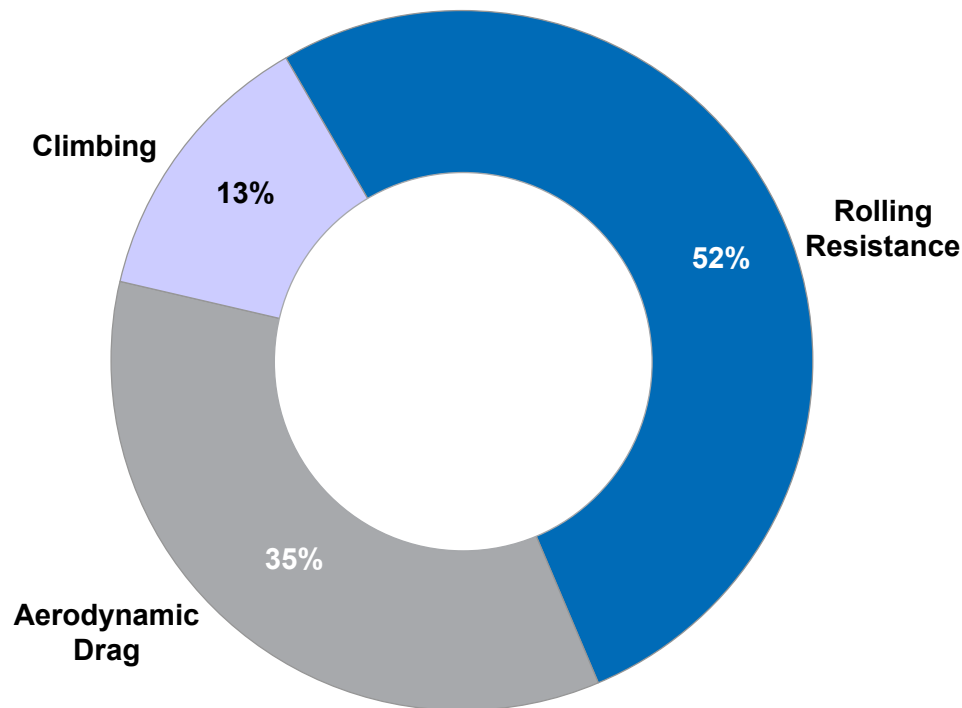

- This energy distribution is based on 1,528 km route over 3 days across the UK involving a mix of cross country roads and motorway where vehicles are assessed for acceleration to national speed limit, gradient etc.

Key Insights

- Ricardo conducted analysis on a “typical” HGV route – the route used by Commercial Motor magazine to test drive trucks
- Over half, 52%, of energy for the vehicle is used to overcome rolling resistance and a third, 35%, to overcome aerodynamic drag
- Vehicle technologies aimed at reducing rolling resistance and aerodynamic drag can therefore have a large impact on the vehicle fuel consumption

Route marked in colours



Source: Ricardo Analysis of Commercial Motor information

Small reductions in rolling resistance and aerodynamic drag can combine to give a large overall benefit in fuel consumption

Improvements in energy consumption through vehicle changes
 Baseline: 44t HGV, 1528km UK mixed cross-country and motorway cycle

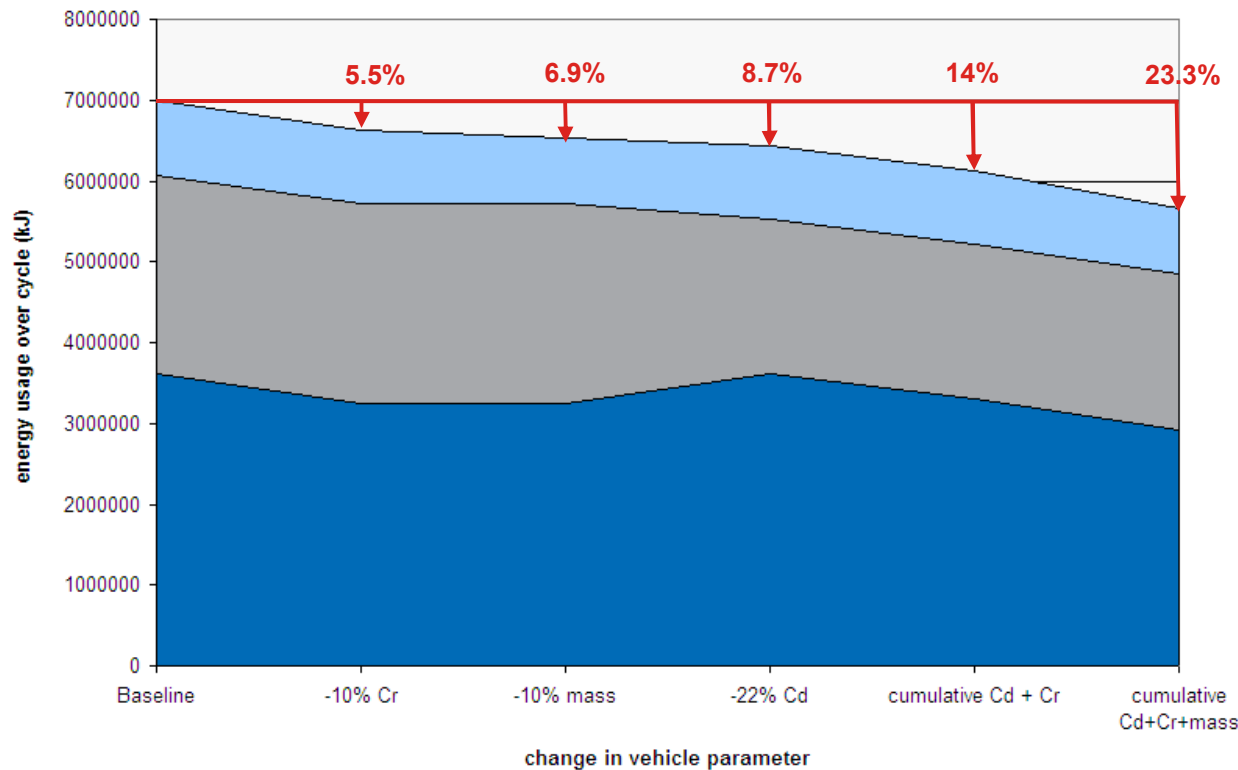

- For example, using the energy distribution previously given:
 - A 10% reduction in rolling resistance would result in a 5.5% reduction in fuel consumption
 - Likewise a 22% reduction in aerodynamic drag would result in an 8.7% improvement in fuel consumption
- For fuel consumption benefits to be noticeable to fleet owners, benefits need to be in excess of 2% to be out of the usual variations in fuel consumption

- **Feasibility Analysis**
 - **Vehicle Technologies**
 - **Aerodynamics**
 - Rolling Resistance
 - Driver Behaviour
 - Electric Bodies
 - Powertrain Technologies
 - Fuel Technologies

Aerodynamic trailers have the potential to substantially reduce CO₂ emissions with limited impact on usage, costs and safety



Aerodynamic Trailers

- **Concept:** Aerodynamic trailers using a teardrop shape to reduce aerodynamic drag of vehicle
- **Base Functioning:** Trailers are designed to follow a teardrop shape rising up from standard 4m height of cab to a max. of 4.5m and then reducing to the rear. The design also features full side skirts to help minimise aerodynamic drag
- **CO₂ Benefit:** Average of circa 10% but varies with application and vehicle usage. Most benefit on constant high speed routes
- **Costs:** Typical additional £3k cost with limited environmental impact due to complex manufacturing process for aluminium roof rails

Safety and Limitations

- ✓ High potential reduction in fuel consumption and CO₂ emissions
- ✓ Can be used with existing cab design
- ✓ No impact of vehicle safety
- ✗ Loss of load volume for double deck applications

Technology Applicability

- Best suited to long-haul motorway type driving for maximum benefit
- Best suited for applications where use can be made of additional load volume to further improve fleet emissions

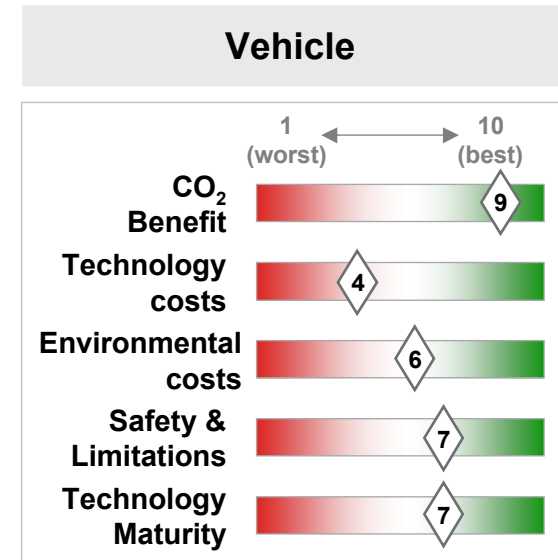

Visualisation



Picture: DHL Teardrop trailer (Don-Bur)

Aerodynamic trailers employ a teardrop shape to optimise air-flow and minimise turbulence



Technology Description

- Teardrop shaped trailers for articulated vehicles have been developed, which aim to minimise vehicle drag. The trailer mimics the shape of a teardrop with a continuous curved roof which rises slightly from the cab end, tapering toward the rear. The front bulkhead also leans forward slightly to reduce the gap between the cab and trailer further reducing turbulence. Rounded corners and full side skirts complete the package



Standard 4m high trailer



Teardrop trailer

Blue lines show linear air-flow whilst orange areas represent turbulence

CO₂ benefit offered by teardrop trailers can be as high as 23%, but averages closer to 10% for a range of applications

CO₂ Benefit

Box Van

- From a range of trials of Don-Bur's teardrop box van trailers, CO₂ reduction varies from 4% to 23.7% savings depending on the type of operation
- Lowest benefits were seen from operations with limited or no constant high-speed operation and maximum benefit from constant speed tests
- **Average CO₂ benefit** from trials to date (excluding track tests) is **11.2%**

Curtain Side

- For curtain side trailers, CO₂ benefits are not as high as box vans and range from 5.6% to 14.7%, **averaging out at 8.6%**
- Trials of the curtain side trailer with DHL have resulted in 9% CO₂ benefit
- It is not stated over what type of operation these figures for curtain side vehicles are achieved

Double and Lifting Decks

- The EcoStream double deck curtain sider has been on trial by a number of companies including STD, who under normal operating conditions reported a 16.7% improvement in CO₂ emissions
- It is also reported by Don-Bur that four other operators report similar savings, but no detail is provided

CO₂ Benefit

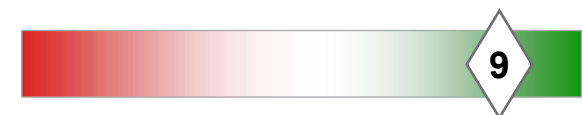

A £3k premium is associated with the teardrop trailer over a base trailer with some environmental impact for manufacture



Technology and Environmental Cost

Technology

- On average teardrop trailers cost an extra £1,500 for the curved roof over a standard box and an additional £1,500 for the addition of trailer skirts
- The percentage on-cost that this represents in terms of trailer cost is very dependent on the type of trailer and its level of specification. For a simple £18k trailer this is an on cost of 17%
- Additional manufacturing costs come from the small amount of additional panelling required and the curved and radiused aluminium roof cant-rails. Rolling these expensive sections is a specialised job

Environmental

- The use of aluminium roof rails is likely to increase the environmental impact of the manufacture of the trailer due to the higher energy required to process aluminium
- Depending on the material used for the trailer walls, an increased environmental impact could occur through the use of aluminium over GRP

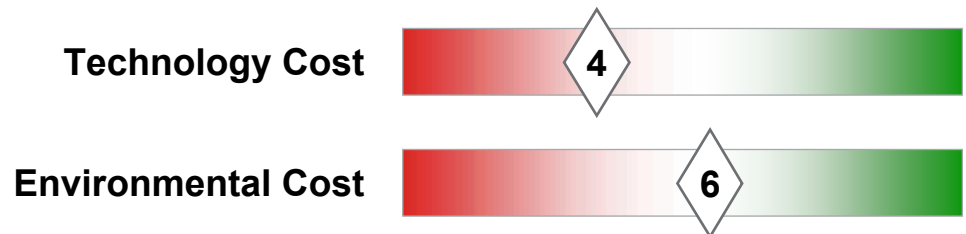

The technology has no safety or vehicle application limitations and is a relatively mature product with applications in the market

Safety and Limitations

- ✓ Due to the curved roof both teardrop box van and curtain-side trailers have an increased load volume of 10%
- ✓ Load capacity for the box van trailer is also increased by 8.5% due to the use of lightweight aluminium in construction, although utilisation of this additional volume is dependent on the commodity being transported
- ✓ The technology presents no new safety risks in application
- ✗ While load volume can be increased for curtain side and box van trailers, for double decks and lifting decks an increase in height is not practical and available load space will be reduced at the front where the roof curves

Technology Maturity

- Teardrop box van trailers are already in the market operated in fleets by M&S and PC-World
- Don-Bur is the only company to offer teardrop trailers, which is a patented design
- Curtain-side teardrop trailers are much newer to market and have recently been trialled and put into the fleet by DHL and ICI Paints AkzoNobel

Safety and Limitations



Maturity

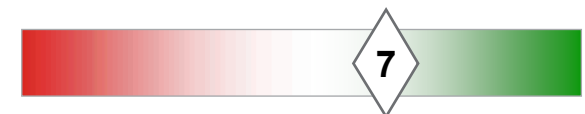

Aerodynamic Fairings can be aftermarket additions to vehicles to improve fuel economy but can be expensive to repair if damaged



Trailer Fairings

- **Concept:** Additional add on's to trailers and cabs that help reduce aerodynamics drag and improve fuel consumption
- **Base Functioning:** Technologies include cab deflectors, trailer side skirts and cab collars, all aimed at reducing aerodynamic drag and can be added as aftermarket additions
- **CO₂ Benefit:** This varies with technology and ranges between 0.1% and 6.5% with cab fairings combined with cab collars offering the greatest reduction
- **Costs:** Like CO₂ benefit this also ranges widely from £250 for trailer roof tapering to £1,700 for trailer / chassis side panels

Safety and Limitations

- ✓ Products can be added as aftermarket components
- ✓ The technology presents no new safety risks in application
- ✗ Addition of aerodynamic fairings adds weight and can reduce the payload
- ✗ Correct adjustment is required to obtain full benefit and if incorrect can lead to a fuel penalty

Technology Applicability

- Greatest benefit from aerodynamic devices is for vehicles that travel the longest distances at highest speeds
- Cab roof fairings are single most effective technology and still offer benefit for local distribution vehicles

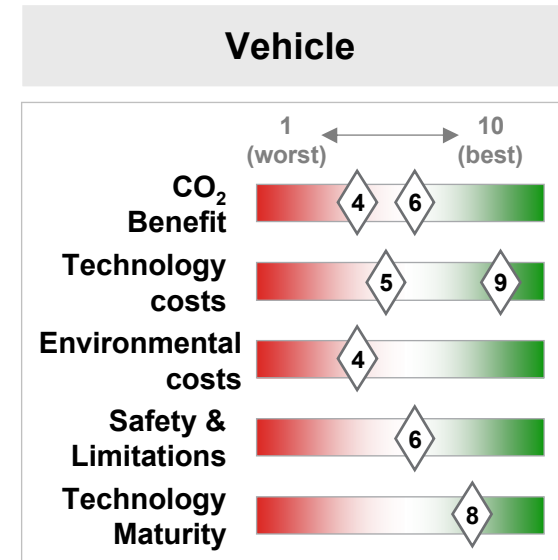

Visualisation

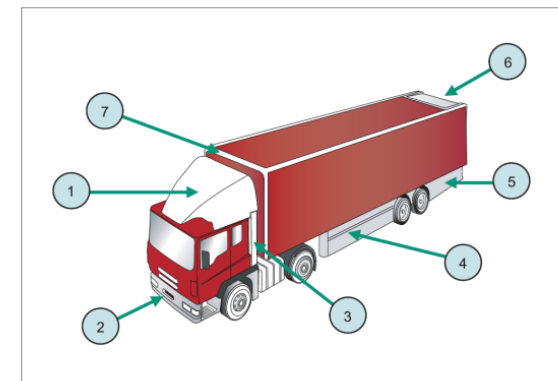

Picture: Examples of truck aerodynamics (Freight Best Practice)

Aerodynamic fairings covers a range of add on devices including cab deflectors, side skirts, cab collars and trailer fairings

Aerodynamic Fairings

- Additional add-on to trailers and cabs that help reduce aerodynamics drag and improve fuel consumption
- Technologies include, cab deflectors, trailer side skirts, cab collars, all aimed at reducing aerodynamic drag and can be added as aftermarket additions

- 1 Cab Deflector / Fairing
- 2 Air Dam
- 3 Cab Collar
- 4 Side Skirt
- 5 Rear Quarter Panel
- 6 Tapered Roof
- 7 Trailer Front Fairing
- 8 Boat-tail plates/extenders

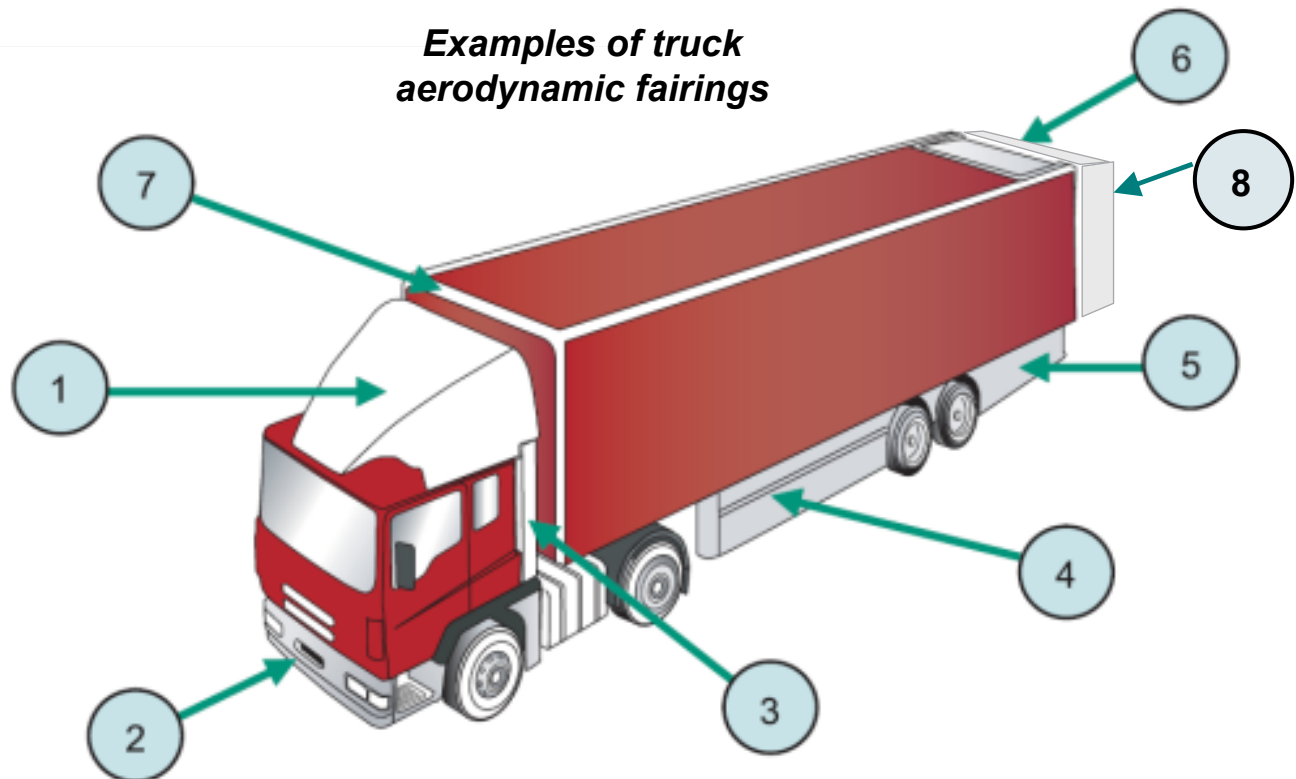

CO₂ benefits offered by aerodynamic devices varies widely by device and vehicle type from as little as 0.1% to 6.5%



CO₂ Benefit

Cab Fairings

- Fuel consumption and hence CO₂ savings for use of a cab deflector are:
 - 17t rigid – 4.8%
 - 40t artic – 3.7%
 - 40t drawbar – 2.3%

Cab Collars

- For articulated vehicles, the addition of a cab collar will reduce fuel consumption and CO₂ emissions by 0.6%
- If cab collars are added along with cab roof fairing fuel consumption and CO₂ reduction increases to:
 - 17t rigid – 6.5%
 - 40 t drawbar – 3.2%

Container Front Fairing

- This technology has the following benefits:
 - 17t rigid – 3.6%
 - 40t artic – 1.8%
 - 40t drawbar (tractor) – 1.6%
 - 40t drawbar (trailer) – 0.7%

Chassis / Trailer Side Panels

- Trailer and chassis side panels have the following benefits:
 - 17t rigid – 1%
 - 40t artic – 0.4%
 - 40t drawbar – 0.7%
- A Canadian trial of side skirts resulted in a reduction in CO₂ emissions of 6.4% over real world running by 3 transport companies

Trailer Roof Tapering

- This technology is unsuitable for retrofitting and can offer the following benefits:
 - 17t rigid – 0.5%
 - 40t artic – 0.3%
 - 40t drawbar (tractor) – 0.1%
 - 40t drawbar (trailer) – 0.3%

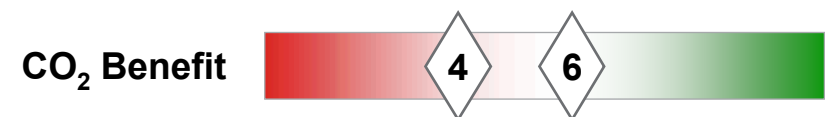

Source: FleetOwner, Aerodynamics and trailers, March 2009; Freight Wing Fleet Trial Programme on Aerodynamic Fairings available at <https://www.tc.gc.ca/programs/environment/ecofreight/casestudies>; Freight Best Practice, Aerodynamics for Efficient Road Freight Operations, June 2007

Many aerodynamic devices have low cost with payback in 2 years or less but impacts the environment with manufacture of additional devices

Technology and Environmental Cost

Technology

- A cab fairing costs £400 (fixed) and £650 (adjustable) and based on the fuel consumption savings has a payback period of 0.2 – 0.5 years
- Cab Collars cost in the region of £350 and have a payback period of 1.2 years
- Container Front Fairings cost in the region of £300 and have a payback based on estimated fuel consumption benefit of 0.3 – 1 year
- The cost of chassis / trailer side panels is somewhere in the region of £750 – £1,700 (depending on vehicle type) with a payback period of between 2.1 and 4.9 years
- AT Dynamics set of side skirts costs \$2,200 for a 53 foot trailer
- Freight Wing have a retail cost for side skirts at between \$1,825 and \$2,450 (Canadian dollars), payback can be achieved between 1.2 and 2.2 years depending on vehicle operation and fuel prices
- Trailer Roof tapering costs as little as £250 but due to the lower fuel consumption benefit will take between 1.7 – 5 years

Environmental

- Impact of additional energy required to manufacture components, typically made of GRP

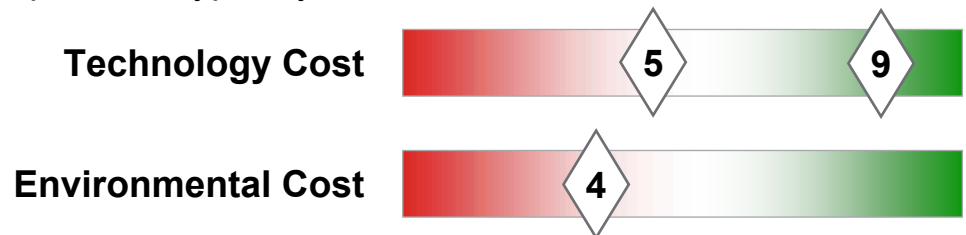

Source: FleetOwner, Aerodynamics and trailers, March 2009; Freight Wing Fleet Trial Programme on Aerodynamic Fairings available at <https://www.tc.gc.ca/programs/environment/ecofreight/casestudies>; Freight Best Practice, Aerodynamics for Efficient Road Freight Operations, June 2007

Aerodynamic devices are mature technology that can be retrofitted to vehicles although they add weight and need careful alignment



Safety and Limitations

- ✓ Products can be added as aftermarket components and such can be used to improve the fuel efficiency of in market trailers at a significantly lower cost than replacement
- ✓ The technology presents no new safety risks in application
- ✗ Addition of aerodynamic fairings adds weight to the trailer and cab and will reduce the payload
- ✗ Components can be expensive to repair if damaged
- ✗ Correct adjustment of cab fairings is required to obtain full benefit and if incorrectly aligned can lead to a fuel penalty
- ✗ Addition of cab decoration, e.g. lights, can negate benefit of any aero device

Technology Maturity

- Technology is mature and has been available to the market for some time
- Cab fairings, cab deflectors, cab collars and trailer and chassis side panels are common in the market and are seen on many vehicles on the road

Latest generation Actros: some low CO₂ powertrain features, but high CO₂ roof mounted lights and horns



Safety and Limitations

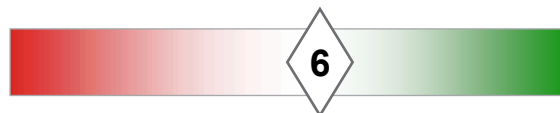

Maturity



Spray reduction mud flaps both improve road safety and help emissions but benefit is limited by weather conditions



Spray Reduction Mud Flaps

- **Concept:** Spraydown has developed a air water separator mud flap, which reduces spray by 40% and also has aerodynamic benefits
- **Base Functioning:** The mud flap separates the water from the air through a series of vertical passages created by vanes which makes the spray change direction a number of times eliminating the water
- **CO₂ Benefit:** Estimated to be around 3.5%
- **Costs:** Costs are estimated to be an additional £2 per unit

Safety and Limitations

- ✓ Reduces vehicle spray by a significant amount improving road safety for other uses
- ✓ Conforms to required legislation
- ✓ Benefit for fuel consumption reduction is independent of weather conditions
- ✓ Can be fitted to any standard mud wing

Technology Applicability

- Greater applicability to heavy duty vehicles as most benefit at high constant speeds
- Can be applied to all vehicle and trailer types

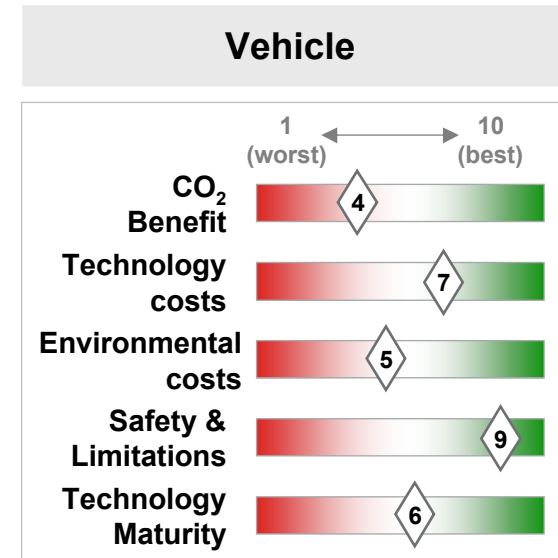

Visualisation

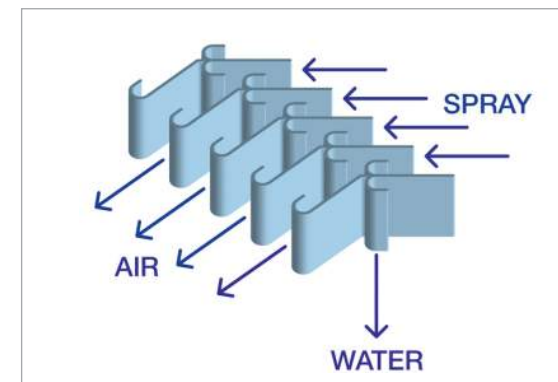

Picture: www.spraydown.com

The spray reduction mud flaps developed by Spraydown separate the air and water by changing direction of the spray

Technology Description

- The mudflap operates by allowing the vehicle spray (comprising air and water) entering these vertical passages formed by the vanes
- The vehicle spray is made to change direction on more than one occasion by virtue of the shape and profile of the vertical baffles
- This change in direction and resultant inertia effects result in the water, being heavier than air, tending to continue to move in a generally straight line until it meets a wall of the vane and subsequent pocket whilst the air component of the spray will readily change direction and continue through the passage
- Some water will escape a first pocket but will tend to be caught by the next pockets provided at other changes of direction in the passage. When caught in a pocket, the water runs down the pocket and is deposited directly on to the road. The air component, however, passes through the passages of the panel to exit at the rear side of the panel

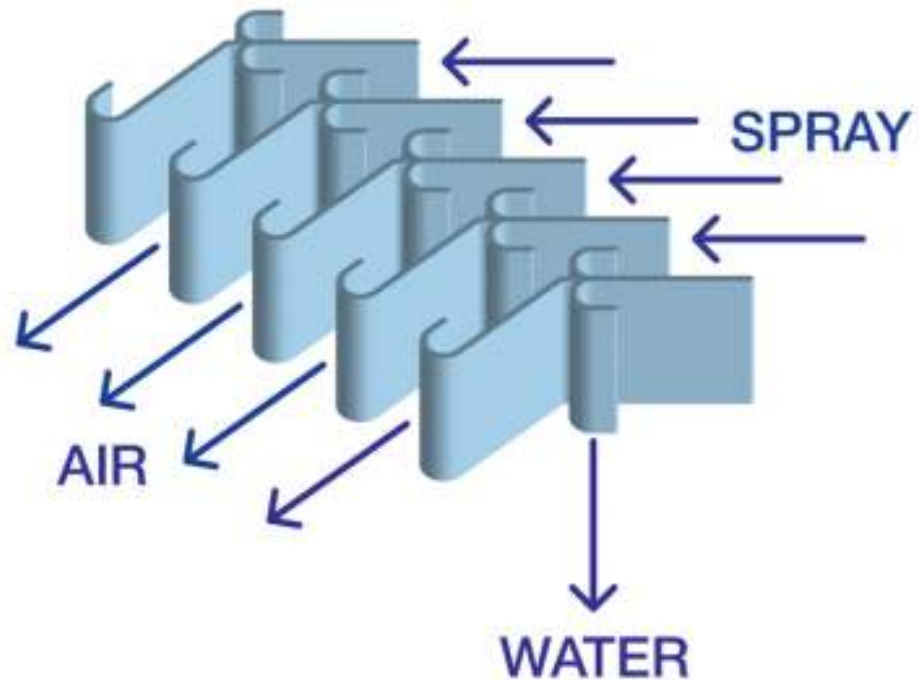

Operation principle of Spraydown technology

CO₂ benefit of the technology is around 3.5% for constant speed tests, but as yet no real world data is available



CO₂ Benefit

- While the spray reduction mudflaps were developed to reduce spray, engineers noticed that the spray pattern behind the vehicle changed and after some CFD analysis noted that the technology also had an aerodynamic benefit
- Independent tests conducted by the Transport Research Laboratory (TRL) resulted in CO₂ savings of 3.8% at a constant speed of 52 mph and 3.65% at a constant speed of 40 mph
- The University of Strathclyde also modelled the technology and indicated that fuel savings of around 2% would be possible
- However no real world data is provided and it is anticipated that real world operation would see less benefit than the TRL constant speed tests
- Greatest benefit will be for long haul operations where the vehicle is at constant high speed for long periods at a time

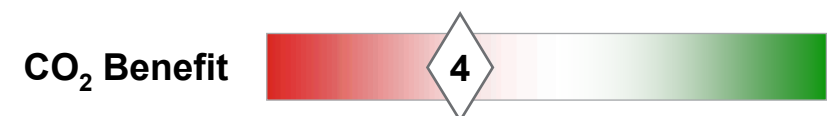

The additional cost of the technology over standard mudflaps is minimal and it is not anticipated to have any environmental impact

Technology and Environmental Cost

Technology

- Spraydown mudflaps are slightly more expensive than standard mudflaps at around an additional £2 per unit
- Payback time for this technology will be less than one year with the claimed benefit in fuel consumption

Environmental

- Spraydown mudflaps are plastic like the majority of other products on the market so it is not envisaged that the technology will have any greater environmental impact

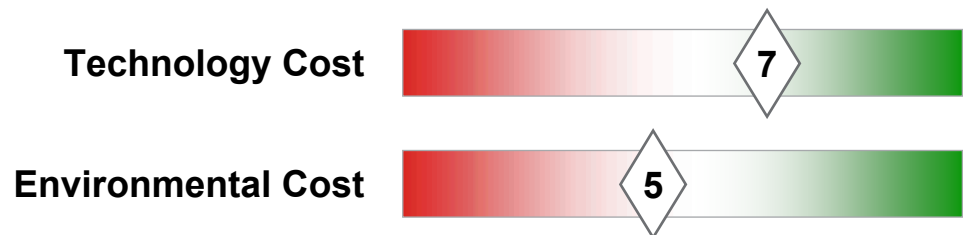

The technology, due to be launched into the market later this year, has no impact on vehicle usage and improves road safety in the wet

Safety and Limitations

- ✓ Reduces vehicle spray by a significant amount improving road safety for other uses
- ✓ Conforms to required legislation
- ✓ Benefit for fuel consumption reduction is independent of weather conditions
- ✓ Can be fitted to any standard mud wing

Technology Maturity

- Product is yet to be launched into the market, but is due for launch later this year
- Product however is in use on fleet trials

Safety and Limitations



Maturity

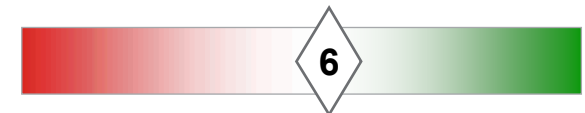

- Abbreviations and Acronyms
- Terminology
- Introduction
- Technology Identification
- **Feasibility Analysis**
 - **Vehicle Technologies**
 - Aerodynamics
 - **Rolling Resistance**
 - Driver Behaviour
 - Electric Bodies
 - Powertrain Technologies
 - Fuel Technologies
- Technology Summary
- Conclusions and Further Work

Low Rolling Resistance Tyres are widely available in the market and able to provide 5% CO₂ benefit at no additional purchase cost



Low Rolling Resistance Tyres

- **Concept:** Tyres specifically designed to lower rolling resistance
- **Base Functioning:** Tyre design to minimise rolling resistance whilst still maintaining the required levels of grip
- **CO₂ Benefit:** Achievable CO₂ benefit depends on the number of tyres replaced but trials suggest 5% is possible
- **Costs:** Limited evidence suggests that there may be no additional cost for low rolling resistance tyres, but tyre lifespan is lower

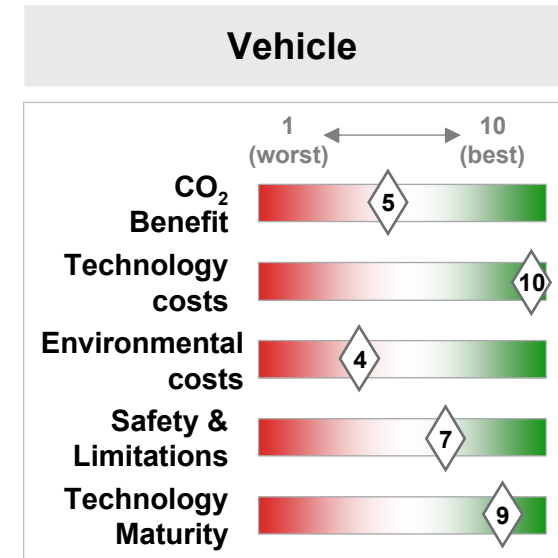

Safety and Limitations

- ✓ Performance of low rolling resistance tyres is comparable to that of standard tyres
- ✓ Low rolling resistance tyres do not have an impact on vehicle functionality
- ✗ Specific low rolling resistance tyres are only available for long haul applications where benefit will be greatest
- ✗ Benefit reduces as tyres wear

Technology Applicability

- Technologies tend to be aimed at long distance vehicles rather than vehicles operating over an urban cycle

Visualisation



Picture: Michelin XZA 2 Energy

Low Rolling Resistance tyres are made from a new rubber compound which reduces the energy consumption of the tyre

Technology Description

- Low rolling resistance tyres are manufactured from a new rubber compound aimed at providing reduced energy consumption
- The introduction of silicon into the rubber compound allows for tyres with lower rolling resistance but the same levels of comfort and grip
- Many tyre manufacturers now offer low rolling resistance tyres, but for truck applications the best compromise between low rolling resistance and durability for the vehicle application needs to be found
- The lowest rolling resistance tyres are aimed at long haul applications, but rolling resistance of these tyres produced by different manufacturers varies greatly as shown in the chart below

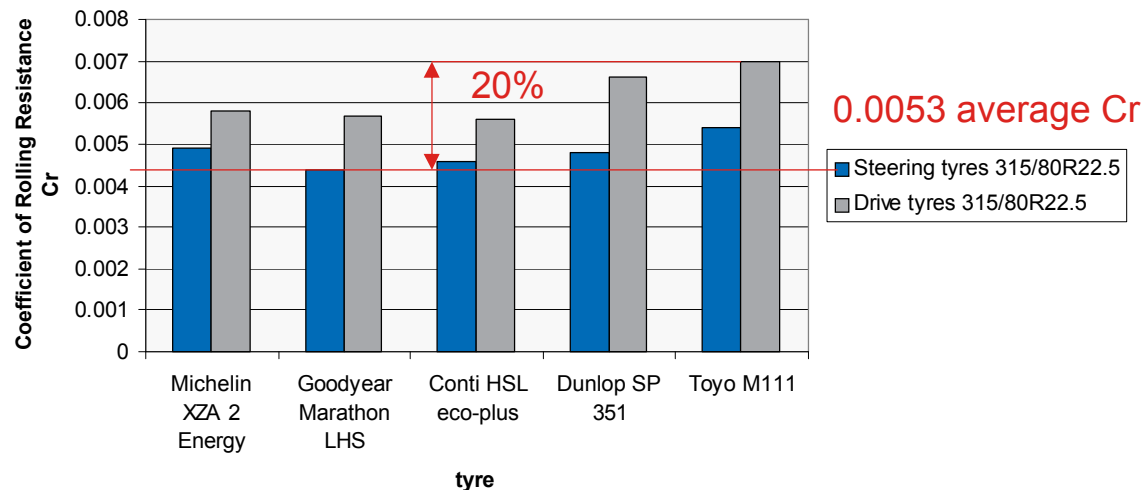

Michelin X Energy Saver Green Tyres

CO₂ benefit offered by low rolling resistance tyres is around 5% both quoted by manufacturers and revealed from real world results



CO₂ Benefit

Michelin

- Reported 0.4l per 100km fuel savings of Michelin X Energy SaverGreen over Michelin's standard energy tyres
- 6% benefit when all tyres are energy saving compared to standard tyres

Goodyear

- Goodyear report fuel consumption reduction of 8% over SAE testing for their FuelMax™ technology over standard Goodyear tyres, but expect 4% in real world operation

Continental

- Claim 4% CO₂ benefit when using a complete set of their HSL1 and HDL1 EcoPlus tyres

Freight Best Practice (FBP)

- The FBP conducted trials of low rolling resistance tyres in 2006, concluding that they offer benefits of between 5.2% and 8% in test track trials comparing fuel consumption of tractor trailers using standard and low rolling resistance tyres
- Fleet trials conducted by Walkers resulted in a 13% reduction in fuel consumption of a vehicle using low rolling resistance tyres compared to that using standard tyres

Fuel Efficiency Trials Research

- Trials of two heavy articulated vehicles resulted in reduction in fuel consumption and hence CO₂ emissions of 4.72% through use of energy efficient tyres

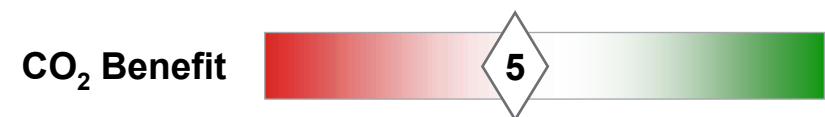

Low Rolling Resistance tyres have no additional on cost to standard tyres but due to lower life have a greater environmental impact



Technology and Environmental Cost

Technology

- According to the tyre manufacturer in the report on Fuel Efficiency Trials Research by Faber Maunsell, there is no difference in tyre cost between standard and fuel efficient tyres, with average costs around £300 per tyre
- Assuming fuel efficient tyres are fitted to all wheels on a 4x2 tractor, the cost per km of fuel efficient tyres is 0.3p/km, while saving is 0.7p/km (based on fuel consumption saving of 4.7% and fuel price of 95 pence per litre), which equates to a £700 saving over the 100,000 km lifespan of the tyre
- However due to the lower lifespan of the tyres, disposal costs may increase as tyres will need to be changed at more frequent intervals
- **Environmental**
- Fuel efficient tyres may have a greater adverse impact on the environment as their lifespan is less than that of a standard tyre, 100,000 km lifespan compared to 120,000 km lifespan, and as such the tyres will be changes at increased frequency
- As tyres are difficult to recyclable this will increase the number of tyres going to land fill
- May be a slightly beneficial interaction with drive-by noise

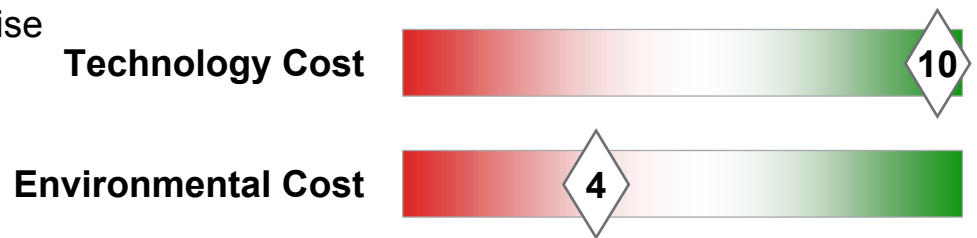

Low rolling resistance tyres are available in the market but are targeted specifically at long haul applications only

Safety and Limitations

- ✓ Performance of low rolling resistance tyres is comparable to that of standard tyres
- ✓ Low rolling resistance tyres do not have an impact on vehicle functionality, no correlation with wet stopping distance
- ✗ As is currently the case tyre selection is based on vehicle application
 - Specific low rolling resistance tyres are only available for long haul applications where benefit will be greatest
- ✗ Fuel economy benefit of low rolling resistance tyres will reduce as tyres wears, as rolling resistance of worn tyres is lower than that of new

Technology Maturity

- Michelin X Energy Saver Green tyres are available in the market
- A number of different fleets have trialled low rolling resistance tyres with successes

Safety and Limitations

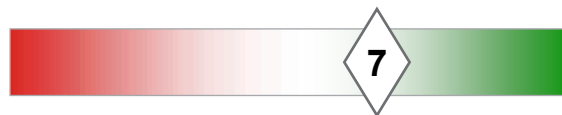

Maturity

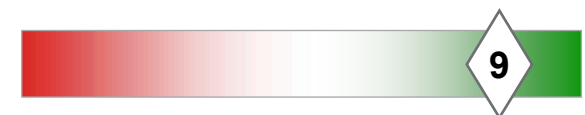

Single Wide Tyres offer an increase in payload along with a reduction in fuel consumption but fitment is limited by legislation

Single Wide Tyres

- **Concept:** Replacement of dual tyres to a single wide tyre
- **Base Functioning:** Single wide tyres with lower aspect ratio which can replace dual tyres on an axle
- **CO₂ Benefit:** 2% reduction for single tractor axle and between 6% to 10% for whole vehicle
- **Costs:** A single wide tyre is approximately the same as two thinner tyres and has similar life span

Safety and Limitations

- ✓ Lighter weight increasing payload
- ✓ Tyre wear rate comparable to conventional tires
- ✗ Legislation requires twin wheels on the drive axle of vehicles over 40 tonnes
- ✗ Requires fitment of a tyre pressure monitoring system
- ✗ Increased damage to roads, particularly those with a thin top layer
 - Initial tests on new generation wide-base tyres indicates single wide are no worse than standard

Technology Applicability

- Most applicable for vehicles travelling long distances
- More benefit for applications where payload increase is of benefit

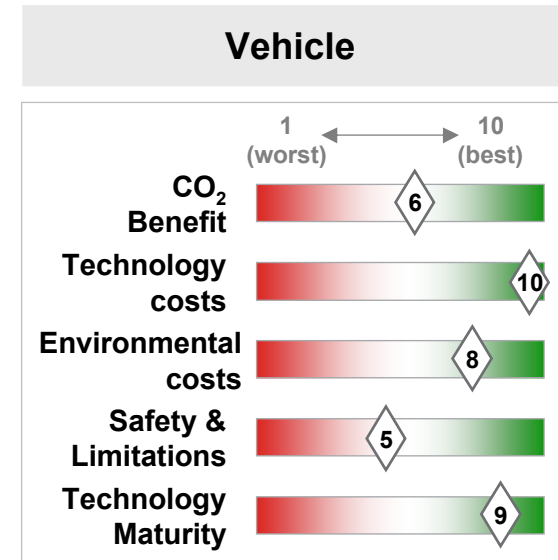

Visualisation



Picture: Michelin X One (Michelin Corporate Website)

Single Wide Tyres are wider lower profile tyres that can be used to replace dual tyres on an axle with the same axle loading



Technology Description

- Tractors and trailers usually use dual tyres on the drive and other axles in order to spread the load and provide adequate levels of grip and comfort
- Conventional tyre design has allowed only relatively tall aspect ratios so tyre footprints and load carrying capacity were limited. With a new tyre construction, lower aspect ratios are possible, allowing the construction of a tyre with the same footprint as a dual set
- These tyres are wide based tyres or ‘Super Singles’ and are smaller in diameter than conventional tyres but can carry the same axle loading

Michelin X-One Wide Tyre



Single Wide tyres offer good real world CO₂ benefits of an average 6% but as high as 10% for fully loaded vehicles

CO₂ Benefit

VDA

- A report by the VDA on clean commercial vehicles estimates that the use of single wide tyres can reduce fuel consumption by 2% (one pair on rear axle rather than duals)

US EPA

- Recent tests of wide-base tyres indicate a potential fuel economy improvement of 2% to 5% compared to equivalent dual tires

Michelin

- Michelin report an 8% reduction of CO₂ for single wide tyres over dual tyres when Michelin A2 Energy tyres are fitted as a complete set on vehicle
- Tests conducted according to SAE J1321 Evaluation show an average 8.7% reduction in CO₂ emissions for use of single wide tyres over dual
- Further SAE testing of Michelin X One tyres show CO₂ savings of 6% for highway driving at 55 mph, 12.6% for highway driving at 65 mph and 10% on suburban test cycle

Continental

- Continental claim that a 5% reduction in CO₂ emissions is possible when using single wide trailer tyres over comparable trailer tyres

Oak Ridge National Laboratory

- Conducted a 4 year study to compare Michelin X One single wide tyres to conventional dual tyres which involved more than 700,000 real-world miles
- Half of the tractors were outfitted with Michelin X One single wide tires while the other half where equipped with standard dual tires. Half of the trailers were outfitted with Michelin X One single wide's, two with standard dual tires, and three with dual retread tires
- Oak Ridge researchers found significant fuel efficiency improvement over dual tires when wide singles were in use – 6% overall and 10% with fully-loaded tractor-trailers

CO₂ Benefit

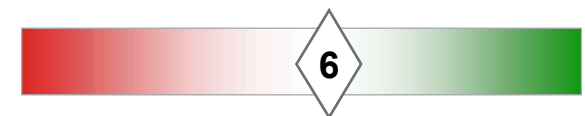

Source: Verband der Automobile (VDA), The Commercial Vehicle – environmentally friendly and efficient; Bachman, L.J., Erb, A and Bynum, C., Effect of Single Wide Tyres and Trailer Aerodynamics on Fuel Economy and NOx Emissions of Class 8 Line-Haul Tractor Trailers, SAE Paper 05CV-45; Diller, T., Matthews, R., Hall, M., DeFries, T. and Shoffner, B., Development of the Texas Drayage Truck Cycle and Its Use to Determine the Effects of Low Rolling Resistance Tires on the NOx Emissions and Fuel Economy, 2009-01-0943; US EPA, A glance at clean freight strategy single wide-based tires; Single Wide Tires , Heavy Duty Trucking Magazine, January 2008, available at: <http://www.ride-on.com/newsDetails.asp?nid=48>

While it may not be economical to refit an existing truck, pay back is instantaneous for new trucks and has lower environmental impact



Technology and Environmental Cost

Technology

- A single wide-base tire costs about the same as two equivalent dual tires and a single wide-rim wheel typically costs about US\$130 less than two standard wheels
- Retrofitting existing trucks with wide-base tires and wheels may not be cost effective. However, for new trucks, the "payback" is instantaneous, since the initial savings could exceed \$1,000. In addition, fuel savings begin immediately
- Fitting wide single tyres over duals on an axle can save 130kg, delivering increased payload capacity

Environmental

- Environmental impact of the super wide tyres is lower due to less scrap rubber, with Bridgestone quoting 25% less for their GREATEC tyre

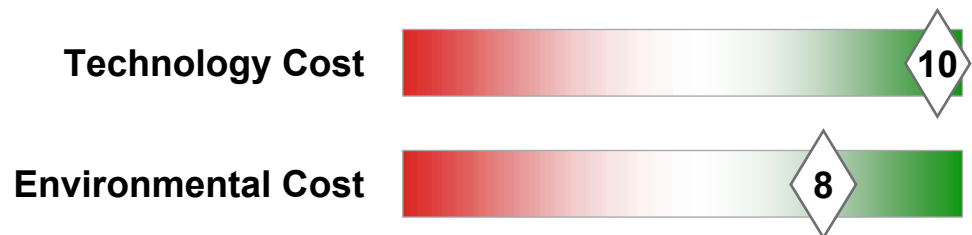

The technology is mature and been in the market for several years although uptake has been limited by legislation despite benefits



Safety and Limitations

- ✓ Lighter weight than dual tyres reducing vehicle weight or increasing payload
- ✓ Lower rolling resistance than dual tyres aiding fuel consumption benefit
- ✓ Single wide trailer tyres offer height saving of 30mm enabling lowering of trailer deck to increase load volume for enough height for 3 euro pallets without increasing 4m max height
- ✓ Tyre wear rate comparable to conventional tires
- ✗ Legislation requires twin wheels on the drive axle of vehicles over 40 tonnes
 - Cannot be used on largest volume selling 6x2's
- ✗ Requires fitment of a tyre pressure monitoring system which will alert the driver to a slow puncture
- ✗ Increased damage to roads, particularly those with a thin top layer
 - New generation wide-base tyres have a different aspect, and initial U.S. tests indicate these tyres cause no more damage than standard tyres

Safety and Limitations



Technology Maturity

- Single wide tyres have been available in the market since 2003 but uptake has been limited by legislation
- Continental expected a 10% growth year on year in Europe of single wide trailer tyres from 2006 to 2010

Maturity



Source: US EPA, A glance at clean freight strategy single wide-based tires; Continental Press Release , 30th March 2006; <http://www.roadtransport.com/blogs/big-lorry-blog/2007/07/biglorryblog-on-the-latest-con.html>

Automatic Tyre Pressure Adjustment monitors and adjusts tyre pressures to improve tyre safety and reduce fuel consumption

Automatic Tyre Pressure Adjustment

- **Concept:** Automatic tyre pressure monitoring automatically monitors and adjust tyre pressures
- **Base Functioning:** Automatic Tyre Pressure systems use the air compressor on the vehicle to automatically monitor and adjust tyre pressures to optimum levels for load and terrain conditions
- **CO₂ Benefit:** Estimated to be 7 – 8% based on the typical volume of vehicles running with under inflated tyres
- **Costs:** Cost for purchase and installation is circa £10,000 and the system can be re-fitted to second and third generation vehicles

Safety and Limitations

- ✓ Systems can be reused on second and third generation vehicles, improving the return on investment
- ✓ Reduction in tyre replacement and maintenance costs due to reduced tyre wear and vibration
- ✓ Tyre wear improved with much more even wear on drive axles
- ✓ Improved safety due to lower tyre wear

Technology Applicability

- Applicable to all vehicles, but benefit likely to be greatest on high mileage vehicles and those operating on a range of different terrains

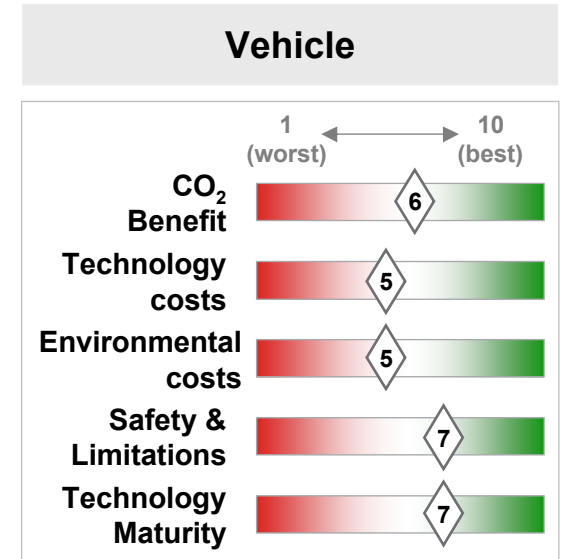

Visualisation



Picture: Automatic Tyre Pressure System (Freight Best Practice)

Automatic Tyre Pressure Adjustment systems monitor and adjust tyre pressure using the vehicle air compressor



Technology Description

- A 'Tyre Pressure Control System' (TPCS) is an onboard system that electronically controls tyre pressures from the cab of the vehicle whilst in motion using the vehicle's air compressor. It is used for optimising load, speed and air pressure in tyres
- Proper inflation pressure is the most important factor in maximising both tyre safety and tyre mileage, particularly in multiple-axle, multiple-wheel vehicles.
- Correct tyre pressure provides proper sidewall flexing and safe operating temperature of the tyres.
- Under-inflation creates excessive heat, seriously reducing tyre life. It also increases fuel consumption and can cause tyre failure. Under-inflation of tyres is particularly serious when the inside tyre of a dual set begins to lose pressure.

Automatic tyre pressure system



The reduction in CO₂ emissions that Automatic Tyre Pressure systems can bring is estimated to be around 7%

CO₂ Benefit

Road Transport

- Tests by tyre manufacturers have shown that under-inflation by 15% reduces fuel economy by 2.5%. Incorrectly inflated tyres also wear faster and are more prone to premature failure
- Statistically it has been found that approximately a quarter of all commercial vehicle tyres are not sufficiently inflated. This increases wear about 15 to 20%. Practically all blowouts and resulting accidents are caused by a too low tyre pressure
- A too low tyre pressure causes about 7% more fuel consumption with equivalent CO₂ emissions. So, also from an environmental point of view, the maintenance of the correct tyre pressure is of great importance.

VDA

- Correctly inflated tyres could reduce fuel consumption by 8% with an estimated 30% of vehicles on the road running with under inflated tyres

American Trucking Associations

- Fuel efficiency can be affected greatly by low tyre pressure. A set of tires at 60 PSI versus the specification inflation of 100 PSI can reduce fuel economy by up to 6%, as well as destroy the tyre
- A tyre that is 10% under inflated equates to a 0.5% increase in fuel use
- At 30% under inflation, fuel economy drops almost 4%

Freight Best Practice

- Trial of a tyre pressure system in the Scottish Forestry industry resulted in a fuel saving of 3 – 4% per year at 44 tonnes, although one company had an increase of 0.3% through low pressure, low speed use, but this was stipulated to avoid damage to roads

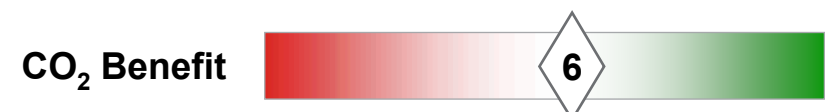

Source: <http://www.roadtransport.com/blogs/big-lorry-blog/2008/02/truck-tyre-pressure-monitoring.html>, http://www.easier.com/view/Trucks/Industry_News/article-173359.html; Tyre Pressure Monitoring and Inflation, American Trucking Association; Freight Best Practice Scotland, Innovation in Scottish Timber Haulage: Tyre Pressure Control Systems (TPCS), April 2009; Verband der Automobile (VDA), The Commercial Vehicle – environmentally friendly and efficient

Automatic Tyre Pressure Systems can achieve payback in around 3 – 5 years but can be re-fitted to second and third generation vehicles



Technology and Environmental Cost

Technology

- Initial installation costs of the systems trialled by the fleets in Scotland were £13,000 for one fleet, but due to increased volume for another fleet and subsequently purchase and installation costs are now £10,000 - £12,000 per vehicle
- Payback for the system is estimated to be between 3 and 5 years depending on the level of fuel consumption benefit achieved
- However the American Trucking Association estimates the payback period to be around 12 months
- Automatic Tyre Pressure Systems have circa a 15 year life span allowing re-fitting of second and third generations of vehicles
- The lifetime repair costs for TPCS are estimated at between 0.01€ / km (ROADEX Project) and 0.02€ / km (Vägverket – Swedish Road Authority)

Environmental

- Automatic Tyre Pressure systems will have some environmental impact associated with their manufacture, but through the proper management of optimum tyre pressure should increase tyre life and reduce the environmental impact that tyres have
 - A tyre that is 20% under inflated equates to 25% less tread wear life

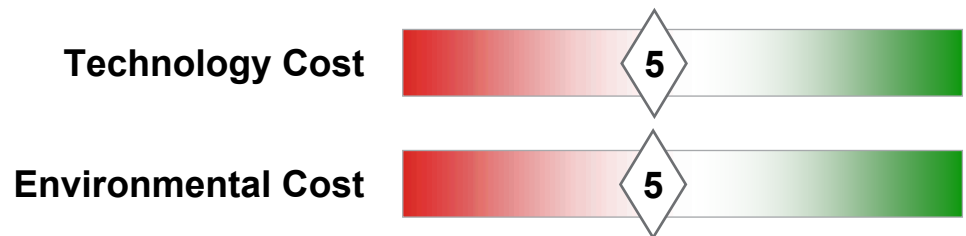

Automatic Tyre Pressure systems are available in the market, can be applied to all vehicles and improve safety reducing risk of tyre failure



Safety and Limitations

- ✓ Systems can be reused on second and third generation vehicles, improving the return on investment
- ✓ Reduction in tyre replacement and maintenance costs due to reduced tyre wear and vibration
- ✓ Tyre wear improved with much more even wear on drive axles
- ✓ Reduction in traffic congestion as often it is caused by an accident with a truck or one immobilised by a flat tyre
- ✓ Improved safety due to lower tyre wear and lower generation of heat in the tyre due to correct inflation
- ✓ Can be applied to all vehicles

Technology Maturity

- A number of systems are available in the market and prices have already dropped due to the increased volumes

Safety and Limitations



Maturity

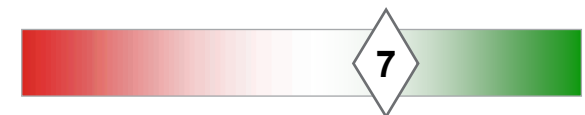

- **Feasibility Analysis**
 - **Vehicle Technologies**
 - Aerodynamics
 - Rolling Resistance
 - **Driver Behaviour**
 - Electric Bodies
 - Powertrain Technologies
 - Fuel Technologies

Predictive Cruise Control is a new to market technology which uses knowledge of the road ahead to optimise fuel consumption



Predictive Cruise Control

- **Concept:** Development of systems that use electronic horizon data to improve the fuel efficiency of vehicles
- **Base Functioning:** Combining GPS with Cruise Control to better understand the road ahead for optimal speed control
- **CO₂ Benefit:** Initial reports indicate fuel economy benefits in the range 2 – 5% but this will vary with route
- **Costs:** No cost information is available but not anticipated to be higher than existing GPS and cruise control

Safety and Limitations

- ✓ The technology can be applied to any truck without limiting usage, although has greater benefit for long haul
- ✓ Technology has no new safety implications over standard cruise control
- ✗ Journey times can increase due to greater speed variations below set speed

Technology Applicability

- Most applicable to long haul vehicle applications where cruise control is used most often

Source: Freightliner debuts RunSmart Predictive Cruise Control, Autoblog, March 22nd 2009; SAE Paper 2004-01-2616, The Predictive Cruise Control – A System to Reduce Fuel Consumption of Heavy Duty Trucks; Hellstroem, Erik, Explicit use of road topography for model predictive cruise control in heavy trucks, 21st February 2005 – Full sources available on detail slides in the attached annex

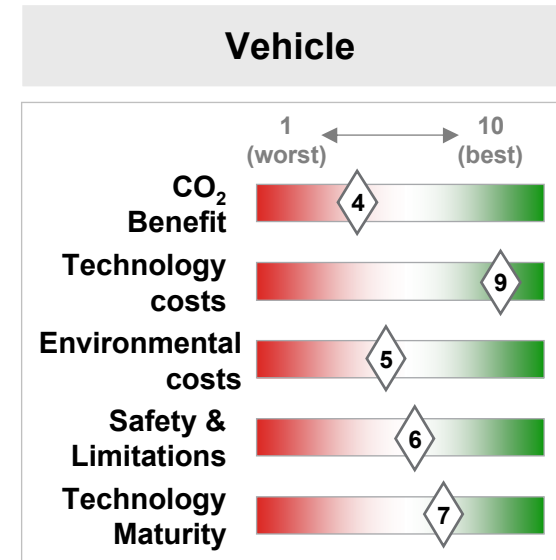

Visualisation



Picture: Freightliner Cascadia (www.freightliner.com)

Predictive Cruise Control uses GPS data to take into account the road ahead to calculate the optimum speed for best fuel economy



Technology Description

- Daimler has developed a Predictive Cruise Control feature which will utilise both map and satellite based route previews to minimise fuel consumption
- It differs from a conventional cruise control system which maintains a set speed regardless of road gradient as the system will search for an optimal route a mile ahead, adjusting engine output to the uphill and downhill gradients ahead
- This information will be processed and the optimum speed calculated which uses the momentum of the truck to maximize fuel economy
- The system, also introduced by Freightliner as RunSmart Predictive Cruise Control. While RunSmart is looking for peak efficiency, it won't sacrifice speed; the system remains within 6% of the set speed

RunSmart is available on Freightliner Detroit Diesel Cascadia with 72" hood



Any CO₂ benefits from Predictive Cruise Control are very much dependent on the route driven but claims are in the region of 2 – 5%



CO₂ Benefit

Daimler Predictive Cruise Control

- In an SAE paper, Daimler claim that PCC has a 2.6 – 5.2% benefit in CO₂ reduction from use. This will vary however with route
- In addition truck loading will affect the benefit as the heavier the vehicle the greater the energy that is required to maintain a speed up a hill. With PCC reducing this unnecessary acceleration, fuel consumption is reduced

Simulations

- A simulation of a typical Scania heavy duty truck over a set route in Sweden has been modelled which results in CO₂ benefit of 2.5%

EU SENTIENCE Program

- The innovITS funded SENTIENCE program developed a EAD (Enhanced Acceleration Deceleration) control strategy which used the road ahead to determine optimum strategy for a hybrid SUV
- This resulted in average CO₂ reduction of 12% for track test work (ranging between 5 and 24%) and has already demonstrated over 5% in real world driving
- Benefit will vary with route and the level of change in the route gradients

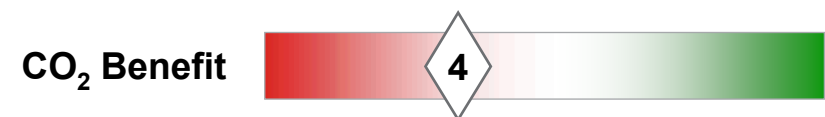

Source: SAE Paper 2004-01-2616, The Predictive Cruise Control – A System to Reduce Fuel Consumption of Heavy Duty Trucks, Sentience, The Use of Electronic Horizon Data to Improve Vehicle Efficiency; Hellstroem, Erik, Explicit use of road topography for model predictive cruise control in heavy trucks, 21st February 2005

It is not expected that the Predictive Cruise Control will cost any more economically or environmentally than existing systems

Technology and Environmental Cost

Technology

- No cost information is available for the technology, but it is not expected to be any higher cost than existing GPS and cruise control

Environmental

- The technology will have no additional impact on the environment over other cruise control and GPS systems

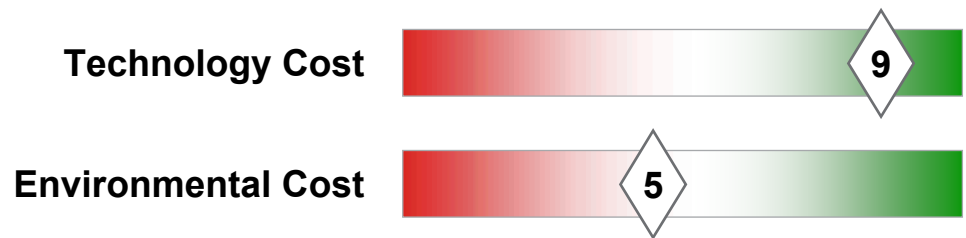

Predictive Cruise Control is a new technology to market which has no additional safety implications or limitations on vehicle use



Safety and Limitations

- ✓ The technology can be applied to any truck without limiting usage, although has greater benefit for long haul
- ✓ Technology has no new safety implications over standard cruise control
- ✗ Journey times can increase due to greater speed variations below set speed
 - Time differences simulated by Daimler for the PCC system range from between +0.3% to +1.9% increase in journey time

Technology Maturity

- Technology is still relatively new and is under development
- Has been introduced by Daimler Trucks in the USA in Freightliner Cascadia in 2009

Safety and Limitations

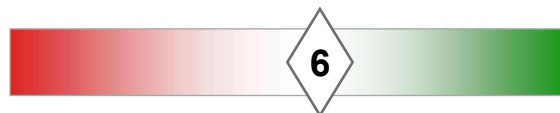

Maturity

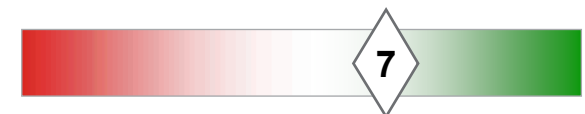

Source: SAE Paper 2004-01-2616, The Predictive Cruise Control – A System to Reduce Fuel Consumption of Heavy Duty Trucks, Sentience, The Use of Electronic Horizon Data to Improve Vehicle Efficiency; Hellstroem, Erik, Explicit use of road topography for model predictive cruise control in heavy trucks, 21st February 2005

Vehicle platooning has potential for CO₂ savings but has significant legislative and safety barriers to overcome for commercialisation



Vehicle Platooning

- **Concept:** Vehicle driving in close proximity to each other to create a train
- **Base Functioning:** Vehicles are able to follow each other closely and safely to reduce aerodynamic drag and fuel consumption and increase safety
- **CO₂ Benefit:** In the region of 20% for motorway speeds
- **Costs:** Anticipated costs of around £305 – £1,600 for additional sensors and active safety features required to implement the technology

Safety and Limitations

- ✓ Automated driving increases comfort
- ✓ Added value when not in a platoon: sensors can be used for active safety
- ✓ Lower operating costs
- ✗ No impact on vehicle functionality
- ✗ Liability issues associated with autonomous vehicle control
- ✗ Contravenes current road regulations
- ✗ System performance in adverse driving conditions
- ✗ Risk of driver underload and of copy cat driving outside the platoon

Technology Applicability

- Greatest benefit is at higher vehicle speeds such as motorway driving
- This technology is therefore more applicable to long haul HGVs where there is a greater business case

Source: Ricardo Research, Ricardo Evaluation – Full sources available on following detail slides

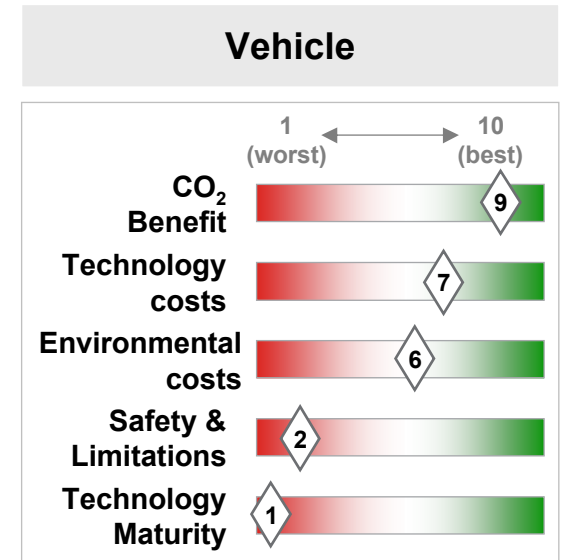

Visualisation

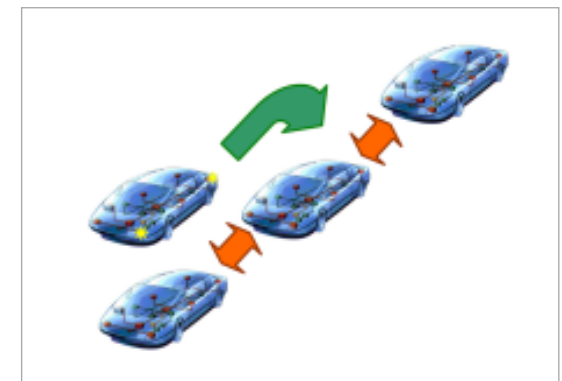

Picture: SATRE FP7 Proposal

Vehicle platooning allows a number of vehicles to follow each other closely but safely reducing vehicle drag and road space taken



Technology Description

- Vehicle platooning is a technology which allows vehicles to follow each other closely but safely and brings benefits in terms of safety, efficiency, mileage, and time of travel of vehicles while also relieving traffic congestion, decreasing pollution and reducing stress for passengers and drivers
- Vehicle platooning makes use of a number of sensor technologies to maintain the correct speed and distance to the vehicle in front and also to maintain the correct lateral lane positioning
- By allowing vehicles to follow each other closely and safely the throughput on the road can be increased reducing congestion and vehicle drag is reduced

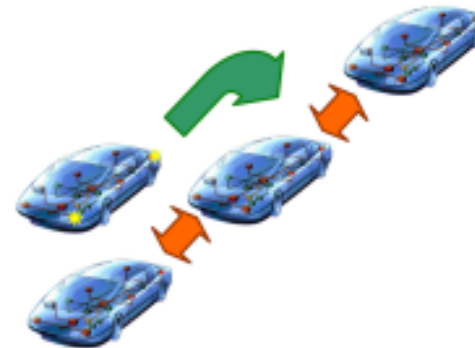
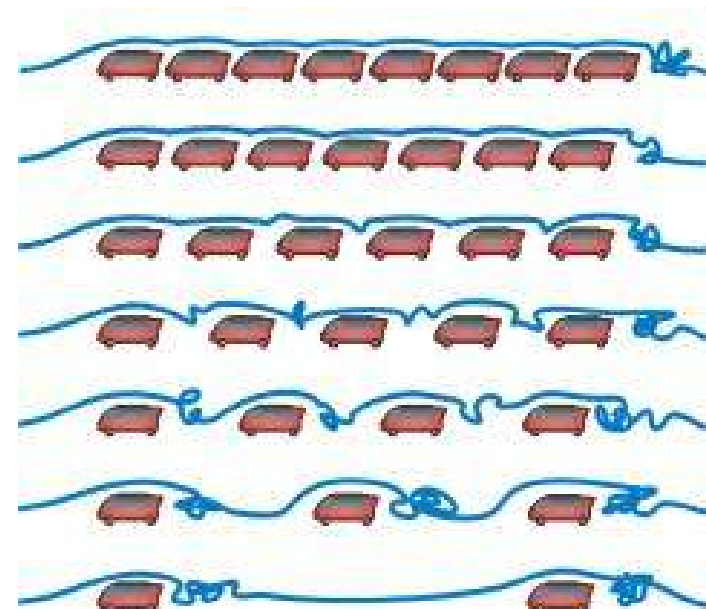

Illustration of vehicle platooning concept

Air streamlines for platooned vehicles



As the main advantage of platooning is that it reduces drag, CO₂ benefit is highest at higher speeds where it can reach 20 – 25%



CO₂ Benefit

- The Californian PATH project in the 1990's estimated that the benefit of platooning for highway (90km/h) driving was approximately 20% reduction in fuel consumption and CO₂ emissions. This can vary depending with the number of vehicles, vehicle spacing and aerodynamic geometry
- The lead vehicle is also expected to have lower energy consumption of up to 10%.
- In urban conditions, where the speed is lower, the estimated benefit is lower. Typically, the benefit is about 7 %. The reason is that the aerodynamics play a lesser role for energy consumption in lower speed. Instead, friction and rolling resistance dominate, and these are not influenced by running the vehicles with close spacing
- The benefit will be similar regardless of the propulsion technology - combustion engine, hybrid or electrical as it is related to reducing vehicle drag
- Finally it is worthy of note that, if the platooned vehicles spend less time halted or forced to repeatedly stop and re-start by congestion, then a further fuel consumption and hence CO₂ benefit will be obtained
- EU Project PROMOTE CHAUFFEUR I and II also demonstrate a 20% reduction in CO₂ at highway speeds

CO₂ Benefit



Vehicles will incur a higher cost due to sensor requirements, but vehicle platooning could reduce new roads requirements



Technology and Environmental Cost

Technology

- Operators will benefit from lower operating costs due to lower fuel consumption
- From a lead vehicle perspective, a long haul truck may typically travel 98,000km and have a good fuel consumption of around 35l/100km (8mpg), this may rise to 32l/100km (8.8mpg) with platooning, giving a diesel fuel price of 82.7ppl, a lead vehicle may save £2,432 per annum from fuel.
- While some platooning proposals do not require additional infrastructure, all platooning vehicles will require additional sensors and active safety systems such as adaptive cruise control and lane departure warning
- These systems for passenger cars are often optional at prices of £890 – £1,600 for ACC and £305 – £440 for LDW, and it is anticipated costs would be similar for HGVs

Environmental

- Close spacing could increase wear and tear of road surface which would require additional maintenance, however the high capacity usage of roads will reduce the number of new roads required to be built
- Due to reduced vehicle drag and lower fuel consumption there will also be reduced emissions

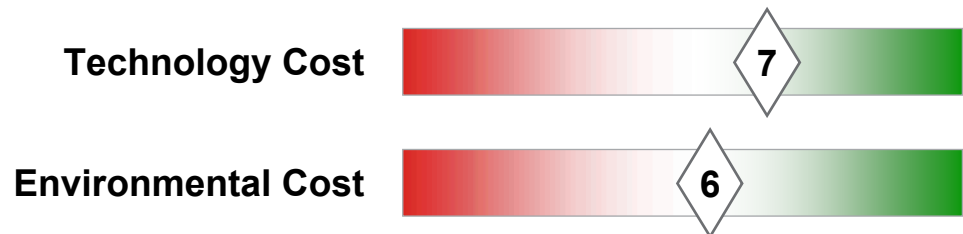

While an area of research there are significant safety, commercial and legislative barriers that need to be overcome for implementation

Safety and Limitations

- ✓ Automated driving increases comfort levels as the ride is much smoother
- ✓ Added value when not in a platoon: sensors can be used for active safety, namely LDW and ACC
- ✓ Lower operating costs
- ✓ No impact on vehicle functionality
- ✗ Liability issues associated with autonomous vehicle control, probability and consequences of system failure
- ✗ Possible feeling of being out of control due to the close proximity to vehicle in front, interaction with and intimidation of other road users
- ✗ Vehicle needs to be equipped with sensors, communication equipment etc.
- ✗ Increased responsibility on the driver
- ✗ Risk of driver underload in platoon vehicles and of copy cat driving outside the platoon
- ✗ Obstruction when passing motorway exits and transient manoeuvres in and out of the platoon
- ✗ System performance in adverse driving conditions
- ✗ Contravenes current road regulations

**Safety and
Limitations**



Technology Maturity

- So far the feasibility of platooning has been analysed in some European (PROMOTE CHAUFFEUR I+II, German national project KONVOI - ongoing) and international projects (PATH in USA)
- These projects were focussing mainly on the technical feasibility of the concept rather than implementation
- Further work required into the safety and regulatory implications before it can be seriously considered

Maturity



SAFED is a well established UK driver training scheme aimed at safe and fuel efficient driving and is applicable to all vehicles



Driver Behaviour

- **Concept:** Driver training for improved fuel economy and safety
- **Base Functioning:** SAFED is a driver training scheme aimed at improving accident prevention and reduction and fuel consumption through both practical and theory
- **CO₂ Benefit:** This varies with driver, but from case studies of all drivers trained it averages at circa 10%. **However, effectiveness is expected to fall off with time after the initial training session**
- **Costs:** The cost of SAFED training varies from £150 to £300 per session

Safety and Limitations

- ✓ Enhanced safe-driving techniques
- ✓ Gear changes reduced by around one-third on test run through block-shifting
- ✓ Drivers feeling more relaxed at the end of the working day
- ✓ No increase in journey time
- ✓ No limitations on vehicle usage
- ✗ Effectiveness falls off with time after the initial training session

Technology Applicability

- SAFED is applicable to any HGV driver and all duty cycles

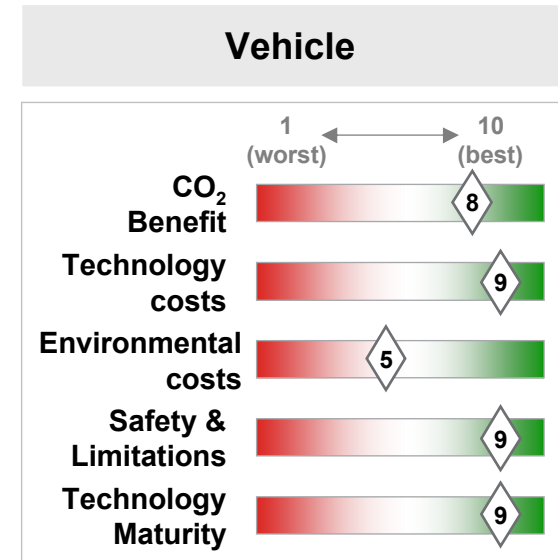

Visualisation



Picture: SAFED logo (www.safed.org.uk)

SAFED is a driver training programme aimed at providing training for more fuel efficient driving and accident prevention and reduction



Technology Description

- The Safe and Fuel Efficient Driving (SAFED) guide was first published in May 2003. It is aimed at improving the safe and fuel efficient driving techniques of Heavy Goods Vehicle (HGV) drivers. The SAFED training programme has been developed specifically to enable both vehicle operators and training providers to implement driver training and development for existing HGV drivers within the road freight industry
- Driver training consists of a full day training course, which includes practical assessments and theory papers based around the following themes:
 - Accident prevention and reduction
 - Fuel Efficient Driving
- There is evidence in the literature for a drop-off in effectiveness with time

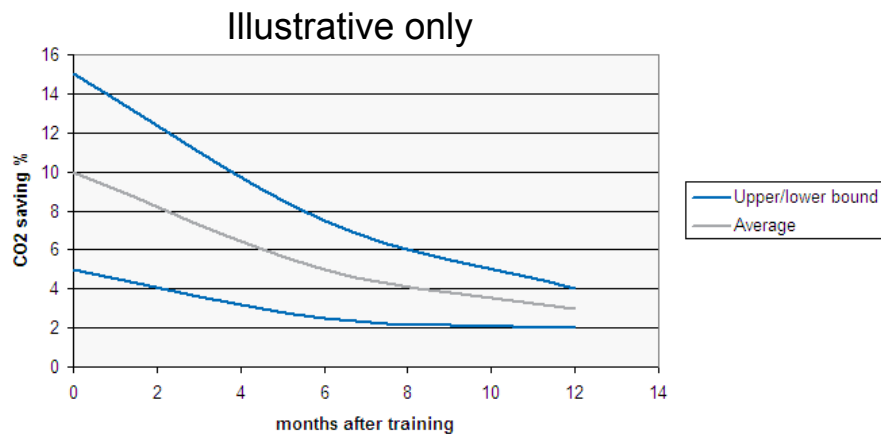

Source: Freight Best Practice, Companies and Drivers Benefit from SAFED for HGVs – A selection of case studies
 TNO SI2.408212 Review and analysis of the reduction potential and costs of technological and other measures to reduce CO₂-emissions from passenger cars

SAFED training provides a wide range of CO₂ benefit depending on the driver ranging from 1.9% – 17%, but averages at 10.1%



CO₂ Benefit

- The CO₂ benefit of SAFED driver training can be assessed from the range of case studies presented by Freight Best Practice. These figures are those achieved on training day and the longevity of these savings is uncertain

Box Vans

- At least 4% improvement in fuel consumption
- Fuel savings* of up to 5%
- Potential fuel savings of 5-10%

Curtain Sides

- Fuel savings of 2.6%
- Average fuel consumption improvements of around 5%
- Fuel consumption reduced by 12%
- Average fuel consumption improvement of 7.3% for 23 drivers
- One driver trainer improved fuel consumption by 13.5% on the day

Flat Beds

- Average fuel savings of 3.2%
- Fuel savings between 1.9% and 5%
- Training day fuel consumption improvements as high as 17%

Tankers and Tippers

- Initial fuel savings of at least 3%

Average

- Fuel consumption data was available from 6,179 of the drivers trained. An average improvement in MPG of 10.01% was recorded. However this represents the saving on day of training and it is acknowledged that effectiveness falls after the initial training period

*Fuel savings are directly related to CO₂ reduction

CO₂ Benefit

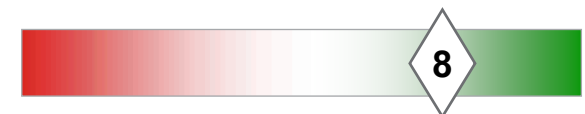

SAFED driver training offers economic incentives despite the initial cost and has no adverse environmental impact



Technology and Environmental Cost

Technology

- The cost can vary from around £150 per session to £300 – this is a result of SAFED operating through a number of trainers with different business practices
- AXA Insurance now offers RHA members who use AXA Direct a 5% discount if all drivers are SAFED trained
- Assuming an average reduction of 10.1% in fuel consumption SAFED training for the 6,375 drivers has resulted in the industry saving £10,456,455 in fuel¹⁾
- With SAFED training also increasing accident reduction, this will have an economic benefit to the country as fewer accidents results in a reduction in insurance costs

Environmental

- Driver training courses will have some adverse environmental impact with the additional driving required

1) This figure has been calculated using the average MPG figure of 10.01%. The figure assumes that the MPG is achievable and can be maintained for one whole year. By looking at the total number of drivers trained and based on average annual mileage, the fuel saving is £10,456,455 per year.

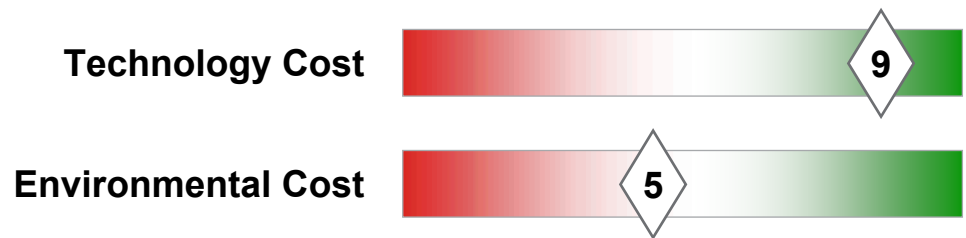

SAFED is a well established driver training program which also enhances safe driving techniques and reduces driver workload



Safety and Limitations

- ✓ Enhanced safe-driving techniques
- ✓ Gear changes reduced by around one-third on test run through block-shifting
- ✓ Drivers feeling more relaxed at the end of the working day
- ✓ No increase in journey time, in fact results of training shows that there was an average decrease in the time taken to complete the second run of 0.92%.
- ✓ No limitations on vehicle usage
- ✗ Effectiveness falls off with time after the initial training session

Technology Maturity

- SAFED driver training has been running since 2003 and has trained over 6,500 drivers
- Training recognised to be as useful for experienced drivers as for new drivers

Safety and Limitations



Maturity



- **Feasibility Analysis**
 - **Vehicle Technologies**
 - Aerodynamics
 - Rolling Resistance
 - Driver Behaviour
 - **Electric Bodies**
 - Powertrain Technologies
 - Fuel Technologies

The use of alternative power for vehicle bodies has good CO₂ reduction potential, however some systems are significant on cost

Electric/ Alternative Fuel Bodies

- **Concept:** Replacement of existing power sources for vehicle bodies which use diesel for power
- **Base Functioning:** Electrification or use of an alternative power source, e.g. nitrogen to drive systems requiring power instead of diesel
- **CO₂ Benefit:** Varies between 10% and 20% depending on the body power system being replaced
- **Costs:** Up to 15% vehicle on cost, but some systems are lower cost

Safety and Limitations

- ✓ No limitations on vehicle usage
- ✓ Electric and nitrogen systems offer quieter and smoother operation
- ✓ Electric and nitrogen systems have low operating and maintenance costs
- ✓ Nitrogen system, unlike mechanical – will not 'top freeze'
- ✗ Safety of nitrogen system

Technology Applicability

- Suited to applications where electrical motors have sufficient torque to drive load
- For use in hybrid vehicle applications where hybrid battery can be used to power trailer

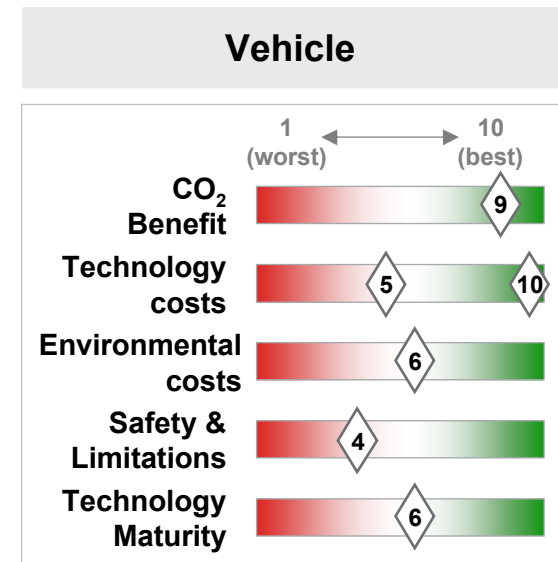

Visualisation



Picture: Volvo Hybrid Refuse Truck (gizmag)

Electrically operated and nitrogen cooled refrigeration trailers are new low carbon alternatives to standard refrigerated trailers



Technology Description

- **Refrigerated Trailers**

- Johnson Truck Bodies in USA offers an all-electric refrigeration, ElectriMax™. As described by the company “This system requires a truck chassis with an automatic transmission and a PTO gear option to drive a mobile power source, which is integral to the operation of the truck and provides power for the refrigeration. The active forced air cooling component provides high performance cooling capacity through an active evaporator, while recharging cold plates and the back-up power source en route. The result is pure performance, very little downtime and minimal recharge time”
- ecoFridge is fundamentally different from mechanical systems. It uses a nitrogen powered system designed and manufactured in Europe by Ukram Industries
- ecoFridge describes the difference between standard refrigerated units and their product:
 - In a standard system air is cooled by the evaporator and projected by the fan on top of the goods at high speed and around 60 times per hour and return to the evaporator. This requires more than 1000 W. In an ecoFridge system, the goods are kept at right temperature by a low Nitrogen down-flow surrounding the pallets at set-up



**Johnson
ElectriMax™**

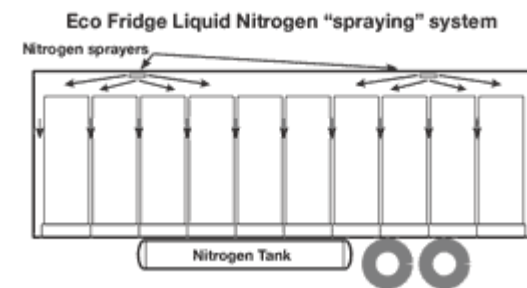
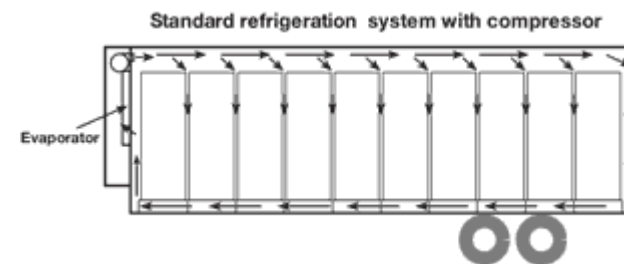

Source: <http://www.finanznachrichten.de/nachrichten-2009-05/13832877-johnson-truck-bodies-latest-refrigeration-solution-delivers-chilling-results-004.htm>; <http://www.ecofridge.info/performance-comparisons.php>

Refuse trucks are also being developed that use electric motors to drive the hydraulic lifting and compacting mechanisms

Technology Description

- **Refuse Trucks**
- Geesink Norba group have developed a plug-in refuse truck body which uses an electric motor to drive the lifting and compacting mechanism, allowing the engine to be stopped during collection
- The system can be used with a conventional or hybrid powertrain and is charged overnight by plugging the vehicle in, and also during operation
- Volvo have launched their first hybrid refuse truck. Of the two vehicles currently on trial one also uses an electric motor to drive the compactor unit, with the battery charged on-board through regenerative braking or over night by plugging in



Geesink Norba Plug-In Refuse Truck



Volvo Hybrid Refuse Truck

Electrification of refrigeration and refuse bodies can have the potential to reduce CO₂ emissions by 10 – 20%



CO₂ Benefit

Johnson Refrigerated Body

- Can saves companies as much as 1,400 US gallons (5,300 litres) of diesel per truck per year, which amounts to 13.9 tonnes CO₂ per truck per year¹⁾
- Given a long haul truck may typically travel 98,000km (similar UK and US) and have fuel consumption of around 35l/100km (8mpg), annual fuel usage is 343,000 litres²⁾
- A saving of 5,300 litres therefore represents a saving in fuel consumption and CO₂ emissions of 15%

ecoFridge

- As the ecoFridge uses nitrogen to cool the trailer its diesel fuel usage is nil
- ecoFridge compare performance assuming a standard refrigerated trailer uses 7,000 litres for 2000 hours operation per year
- On this basis with the same assumed annual mileage and fuel economy as above, CO₂ emissions reduction would be 20%

Norba Plug-In Refuse

- Results from test operations show a fuel saving and hence CO₂ reduction of approx 20% when installed on a diesel driven chassis. When installing on a hybrid chassis the savings potential is even greater

Volvo Refuse Truck

- Potential CO₂ benefit of an additional 10% over standard hybrid refuse truck

Hybrid Refuse Truck Feasibility Study

- A study by the Canadian government into the fuel saving potential of a hybrid refuse truck estimated that CO₂ saving potential from electrification of the compacting mechanism was circa 18%

1) Burning 1 litre of diesel results in 2.63 kg CO₂ emissions (DEFRA)
 2) Figures from DfT, Road Freight Statistics 2007

CO₂ Benefit

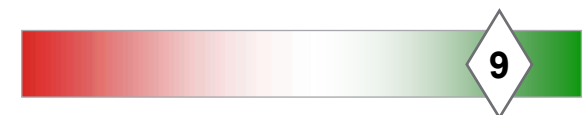

Electrified bodies have a lower environmental impact offering quiet operation, but often come at additional upfront cost



Technology and Environmental Cost

Technology

- A Canadian study into hybrid refuse truck conducted an economic analysis as part of the study which indicated that the cost premium for near-term volume production can be estimated at approximately US\$22,000 (13% vehicle on cost, assuming average price for refuse truck of US\$170,000) for an electric system to drive the compacting mechanism. This cost includes the cost of the additional components, development costs and increased labour to integrate the system into the vehicle
- Assuming the average fuel price during the payback period at current levels of US\$0.70/L, the payback time for the system would be just under 5 years
- ecoFridge can be fitted for a little under the cost of a standard, diesel-powered system. Thereafter, because ecoFridge is virtually maintenance-free, labour, parts and downtime costs will be significantly less than those of a mechanical system. Furthermore, the running cost for a mechanical system rises dramatically after 3–4 years, whereas ecoFridge costs will remain virtually unchanged for at least 20 years
- In terms of lifecycle costs, Johnson’s ElectriMax™ trailer has lower costs due to an operational lifetime of 15 years compared to 5 – 7 years for standard trailers

Environmental

- The Plug-In Refuse system from Norba offers both quieter and smoother operation, which means a better environment for the operator and the surroundings, as the engine can be switched off during collection

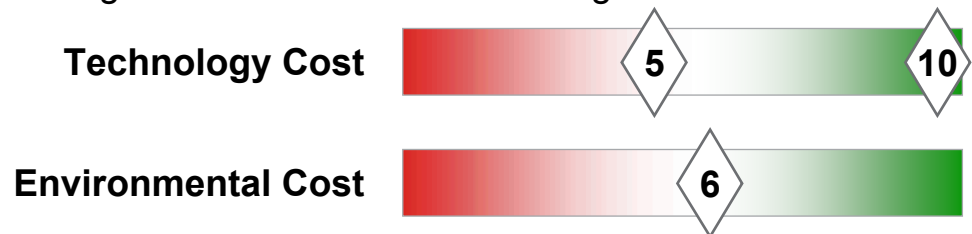

Refrigeration technologies are closer to market than refuse and while they offer no usage limitations, safety needs to be considered

Safety and Limitations

- ✓ No limitations on vehicle usage

Refuse

- ✓ When loading and compacting, the chassis engine is switched off and all operation is powered electrically resulting in quieter and smoother operation
- ✗ Operator and maintenance staff training for dealing with electrical system

Refrigeration

- ✓ Silent running
- ✓ Low operating and maintenance costs
- ✓ Nitrogen system, unlike mechanical – will not 'top freeze' (where cold air is blown in)
- ✗ Safety of nitrogen system, although safety measures are in place
 - Nitrogen system only releases nitrogen into space when doors are closed and will not allow entry until environment has required O₂ levels

Technology Maturity

- The Norba refuse truck is under development in the UK but is already operational in Sweden, Spain, France and other parts of Europe
- Volvo launched two hybrid refuse trucks for trials in 2008
- Johnson's ElectriMax™ is available in the US market
- Asda trialled the ecoFridge in 2008

Safety and Limitations



Maturity

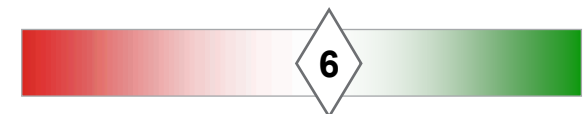

- **Feasibility Analysis**
 - Vehicle Technologies
 - **Powertrain Technologies**
 - **Engine Efficiency**
 - Waste Heat Recovery
 - Alternative Powertrains
 - Transmissions
 - Fuel Technologies

Combustion system optimisation essential to achieve emissions legislation and maintain competitive fuel consumption

Combustion System Optimisation

- Concept:** Improvements in combustion system efficiency with further development of the combustion system:
 - Higher pressure FIE, high capability air/EGR systems
- Base Function:** Optimise NOx-BSFC trade-off when moving to next emissions level. Possibility to improve BSFC at a given emissions level by early adoption
- CO₂ Benefit:** Theoretical maximum of 3% in BSFC (assuming moving from “worst” to “best” technology at the same emissions level). However real figures likely to be much lower (1-2%) and can be strongly masked by vehicle application
- Costs:** Adding costs in technology for powertrain at each emissions level

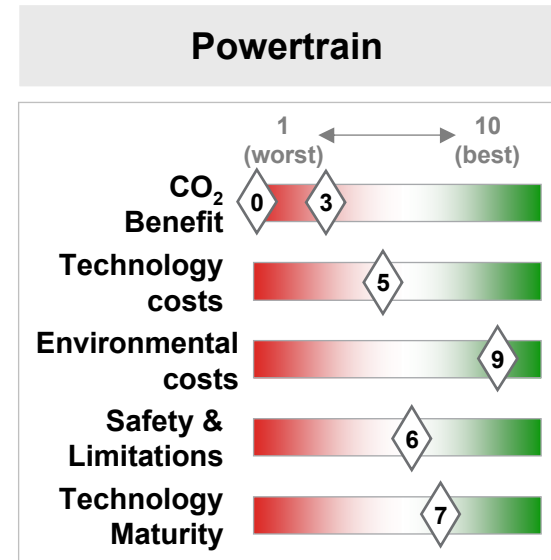

Safety and Limitations

- ✓ Technology available up to Euro 6 with no fuel consumption penalty
- ✓ No impact of vehicle safety
- ✗ Low potential for CO₂ reduction, especially if manufacturers are already using these technologies
- ✗ Essential engine/powertrain development to achieve legislative emission regulations
- ✗ Poorly integrated aftertreatment can lead to a fuel consumption/CO₂ penalty

Technology Applicability

- Technology for Euro 5 in production – lower FC compared to Euro 4
- Euro 6 technology in development status
- Diminishing returns as we move to lower emissions
- Industry resistant to anything which might be seen to mandate particular technologies to meet emissions limits
- Very difficult to use as a proxy for CO₂ reductions because of the complex trade-offs

Visualisation

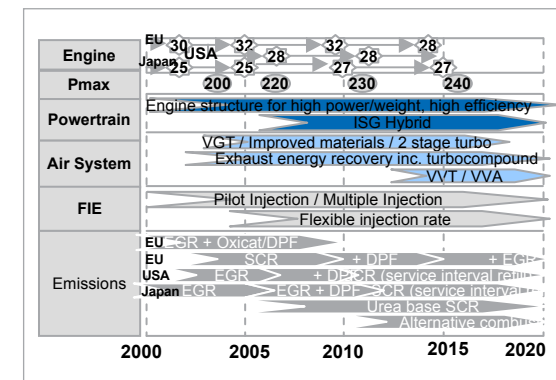

Picture: Ricardo Research, Ricardo Evaluation

Combustion efficiency improvement – Technology overview

Conflicts with the drive for lower engine out NOx

Technology Description

Combustion system optimisation

- Reductions in legislated NOx can result in significant changes in fuel consumption
- Advanced technology, such as high pressure common rail fuel injection systems and 2-stage turbocharger boosting systems can control fuel consumption penalties
- Future aftertreatment systems for Euro 6 (DPF for PM & SCR for NOx) are likely to increase fuel consumption / CO₂ emissions
- Early adoption at Euro 4/5 can provide benefits (Route 2)
- BSFC reduction/control strategies used to maintain neutrality:
 - Injection strategy optimisation, increased pressure
 - Advanced turbocharging and cooling systems

Route 1 – maximising engine out emissions reduction

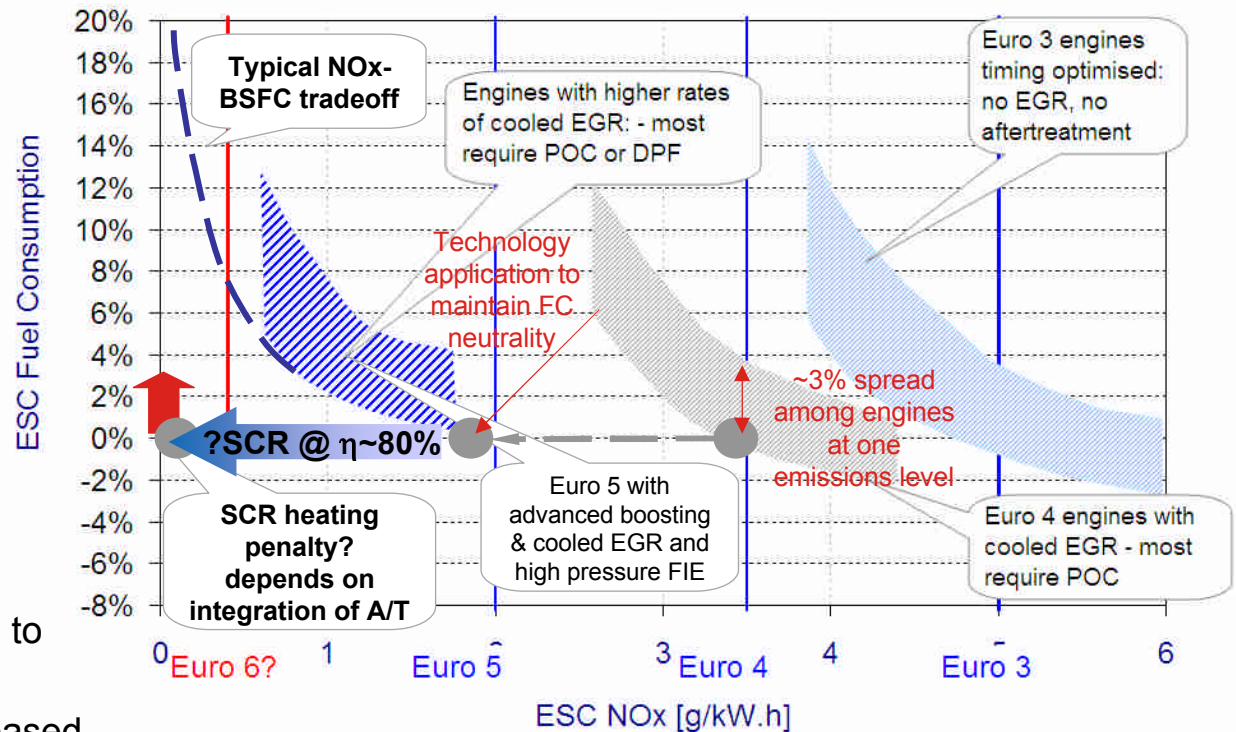

Early adoption of SCR for Euro 4/5 offers theoretical CO₂ benefit. At Euro 6 solutions converge



Technology Description

Combustion system/aftertreatment optimisation

- For Euro 4/5, engine calibration can be optimised back at Euro 2 levels, NOx control is via low/med efficiency SCR
- This gives a BSFC benefit over a Euro 4 engine out NOx optimised engine
- By Euro 6 however, “engine out “ and aftertreatment solutions converge
- BSFC neutrality or penalty is then dependent on SCR integration/heating strategy and engine combustion optimisation – any benefits again depend on the starting point

Route 2 – early adoption of aftertreatment for Euro 4/5

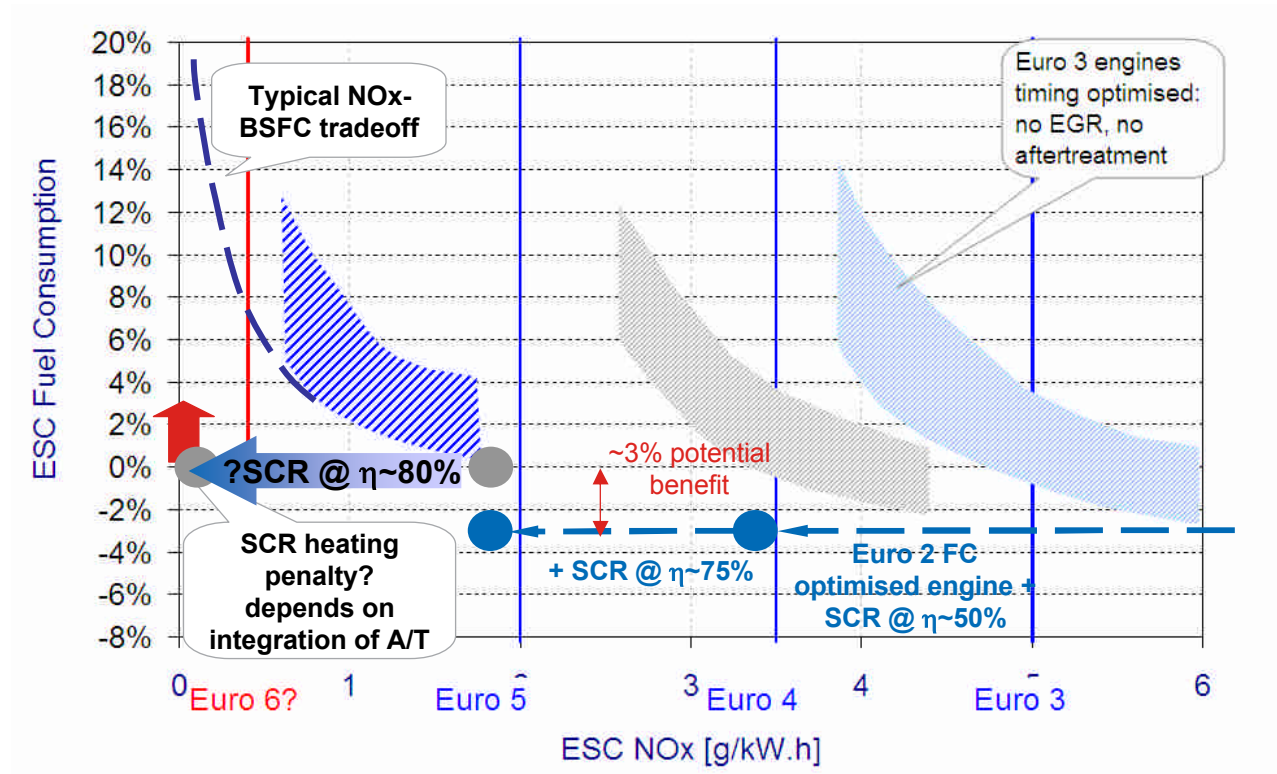

Theoretical benefits of early adoption of SCR for Euro 4/5 not translate into reality



Technology Description

Combustion system/aftertreatment optimisation

- Across the products available at Euro 4, SCR solutions produce a CO₂ benefit of only 1.8%. The spread amongst different manufacturers products is much greater than this, showing significant masking by other factors such as aero, rolling resistance etc. “Indicability” of these technologies is not good
- Running cost includes urea consumption where applicable

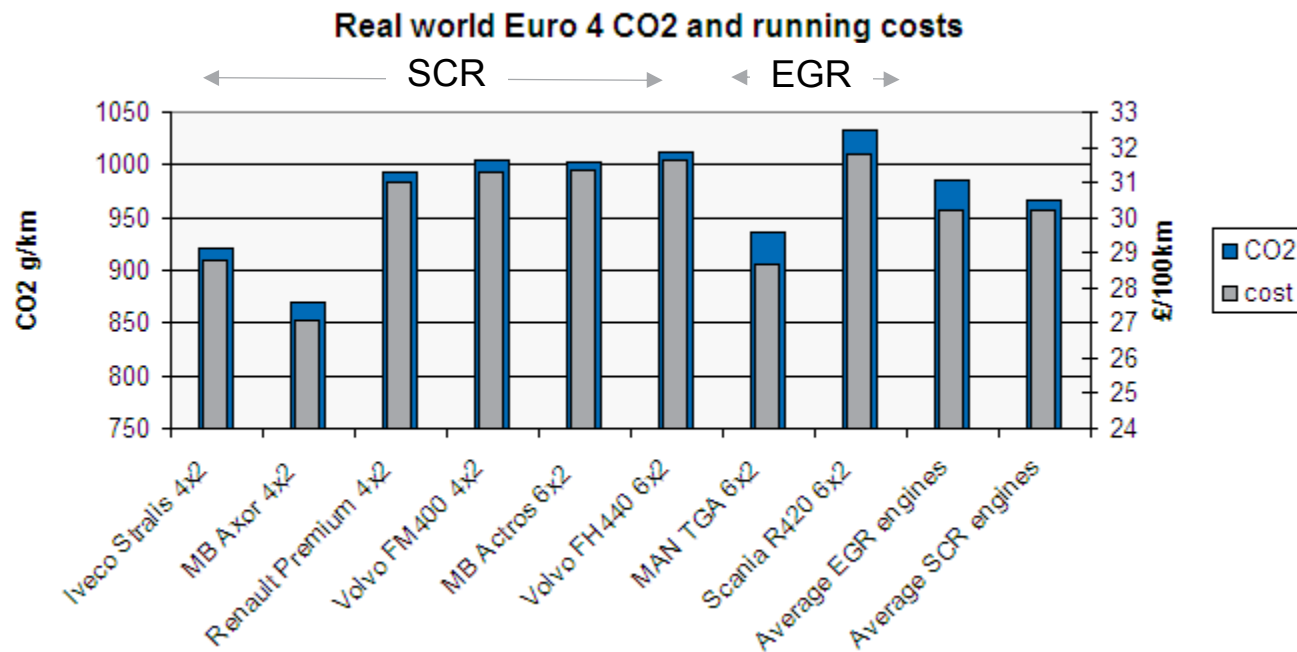

Source: Commercial Motor Euro 4 Test September 2006

Combustion efficiency improvement – Aftertreatment. DPF active regeneration & SCR warm-up strategies increase fuel consumption



Technology Description

- Aftertreatment required to achieve future exhaust emissions legislation like Euro 6
- DPF & SCR aftertreatment systems may increase fuel consumption by 1% ~ 4%, which may offset the fuel consumption improvements from the combustion system optimisation

Aftertreatment Requirements	System Effects	Comments	Effect on fuel consumption
DPF: Active Regeneration	<ul style="list-style-type: none"> • Back Pressure with loading • Active re-generation results in fuel consumption 	<ul style="list-style-type: none"> • Maximise potential for passive regeneration by: <ul style="list-style-type: none"> • Proximity to engine • High exhaust temperature (EGR/AFR control) • Maximum NO₂ in DPF • Minimise back pressure by limiting soot loading • Minimise loading by low engine out soot • Minimise active re-generation by using large volume 	+1% ~ +2%
SCR: Fast warm-up (Thermal Management)	<ul style="list-style-type: none"> • Urea solution injection below 200°C inadvisable • Low temperature and cold start exhaust emissions certification procedures driving requirement for measures to warm SCR systems quickly 	<ul style="list-style-type: none"> • Measure to improve catalyst warm up include: • Compact aftertreatment packaging • Modified breathing (throttle, EGR, backpressure) • Modified FIE strategy (retard, close post inj.) • HC doing of an upstream DOC • (last resort only!) burner • Exhaust heat = wasted energy 	+2% ~ +4%

Note: (1) Urea Injection required for operation of the SCR not discussed here, but is an operating cost like fuel

Target for combustion system optimisation is to achieve emissions targets at the lowest possible fuel consumption (detail summary)



CO₂ Benefit/Effect

Euro 4 engines (Baselines)

- Cooled EGR with particulate catalyst.
 - Typically with Common rail FIE, wastegated TC
- SCR (no PM catalyst) –
 - CO₂ 0%~3% lower than EGR engine, but urea consumption is equivalent to ~4% of fuel by volume

Euro 5 options

- Cooled EGR with particulate catalyst
 - Increased EGR rates (compared to Euro 4) combined with effective EGR cooling
 - Either 2-stage turbocharger system or VGT turbocharger system
 - Higher fuel pressures (>1800 bar)
 - Fuel consumption improvement over Euro 4: 0% - 1.5%
- SCR (no PM catalyst)
 - Limited technology changes over Euro 4, so fuel consumption is 0% - 3% better than Euro 5 EGR engine, but...
 - increased urea rates (equivalent to ~6% of fuel consumption by volume)
 - Larger SCR catalyst (in some cases)

Euro 6 option

- “Prime path”: cooled EGR + SCR + DPF
 - Combination of both Euro 5 technologies
 - Increased rail pressures: >2000 bar
 - SCR NOx reduction efficiency 80-85%
 - 2-stage boost systems with 2 stage inter-cooling
 - Targeting similar fuel consumption to Euro 5, but incorrect integration of SCR may result in need for SCR thermal management with up to 4% penalty
- Optional technology (1): EGR only
 - Very high EGR rates required (up to 40%)
 - 2-stage boosting systems with inter-cooling
 - 2-stage EGR cooling circuits
 - Very high fuel injection pressures
 - Risk of increased fuel consumption
- Optional technology (2): SCR only
 - SCR catalyst efficiencies around 95% required over lifetime of engine requiring extensive thermal management
 - Higher urea consumption rates compared to Euro 5

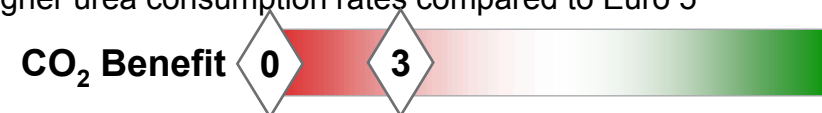

Increased powertrain costs to achieve future emissions targets and competitive fuel consumption / CO₂ emissions



Technology and Environmental Cost

Technology

- Estimated added powertrain costs for Euro 5 technology - £100-500 per unit
- Estimated added powertrain costs for Euro 6 technology - £1000-1400 per unit
- Introduction of new technology like advanced boost system, intercooler and EGR cooler systems, advanced fuel injection systems is primarily driven by emissions compliance, so it is “unfair” to attribute the bulk of this cost to any CO₂ benefit

Environmental

- Essential to fulfil EU emissions regulations and maintain/lower fuel consumption at Euro 4 level
- No significant improvement in lowering fuel consumption / CO₂ emissions with combustion system optimisation without compromising achievement of mandated emissions level
- CO₂ impact of urea consumption is not quantified in this study
- By definition the implementation of emissions driven combustion optimisation will improve the environmental situation over the baseline

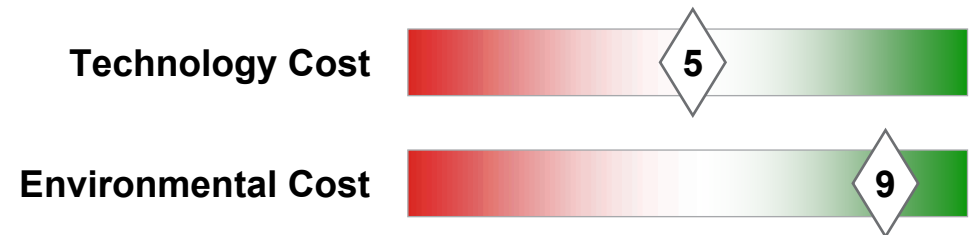

Combustion optimisation does not have safety issues but is limited in state of technology and cost restrictions

Safety and Limitations

- ✔ Technologies for next legislative emission levels are available up to Euro 6
- ✘ Increasing Pmax with higher injection pressures, impacts on base engine design. Design for high Pmax can lead to higher friction
- ✘ Increasing costs for advanced technologies
- ✘ Resistance from manufacturers to mandatory adoption of particular technologies to meet emissions limits

Technology Maturity

- Euro 5 engines in production from all major OEMs
- Certain OEMs have already demonstrated Euro 6 capability
- Euro 6 strategy will include high EGR concepts combined with an SCR aftertreatment solution

Safety and Limitations

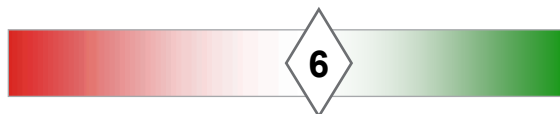

Maturity



Lowering engine friction can improve CO₂ emissions, but the overall impact on engine friction versus CO₂ emissions is rather small



Combustion System Optimisation

- **Concept:** Improvements in engine efficiency by reducing engine friction
- **Base Functioning:**
 - Reduction in engine friction with improvements in piston, piston ring and cylinder liner package as well as crankshaft system in design and surface finish. Improved manufacturing processes
 - Crankshaft / Cylinder axis off-set to reduce force at cylinder fire condition (re-design base engine & production line)
 - Reducing engine oil viscosity and introducing oil additives
- **CO₂ Benefit:**
 - Potential 0.5 % reduction in FC for design and surface improvements
 - Oil specification change with an average ~1.5%
- **Costs:** Adding costs in technology for powertrain and complicating production process

Safety and Limitations

- ✓ Technology available
- ✓ No impact of vehicle safety
- ✗ Low potential for CO₂ reduction
- ✗ Crankshaft/Cylinder off-set only for new engine designs
- ✗ Durability concerns with low viscosity grade oils
- ✗ Not all low viscosity grade oils behave the same

Technology Applicability

- Technology partly introduced in light duty applications
- Low engine friction high importance for new engine design programmes

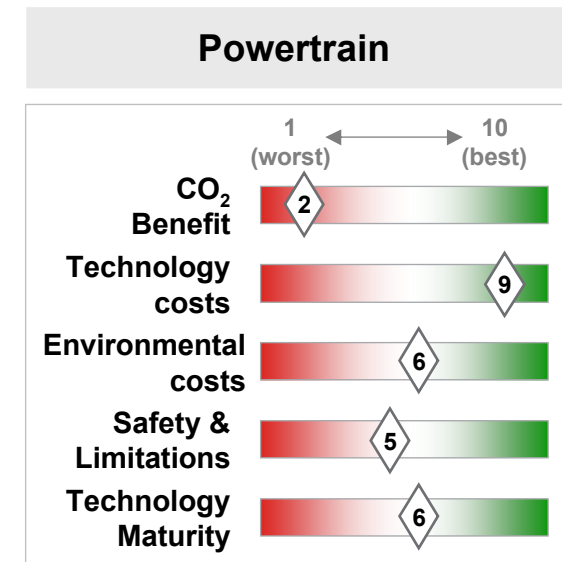

Visualisation



Picture: Heavy duty piston

Engine efficiency improvement – energy balance for HD engine: Engine friction is relatively small fraction of fuel energy - 1.5 %

Technology Description

- Typical engine energy balance at US 2007 / Euro 4 emissions levels
- Improvements in engine friction results as only very small improvements in over all fuel consumption benefits or CO₂ emissions reduction
- 10 % engine friction improvement equals a brake power benefit of 0.36 % at full load, up to 1% at part load
- To put friction in perspective – if all base engine friction was eliminated this would improve fuel consumption by a maximum of 3.6% at maximum power, 10% at mid speed, mid load

HD Engine: Distribution of fuel energy at full load

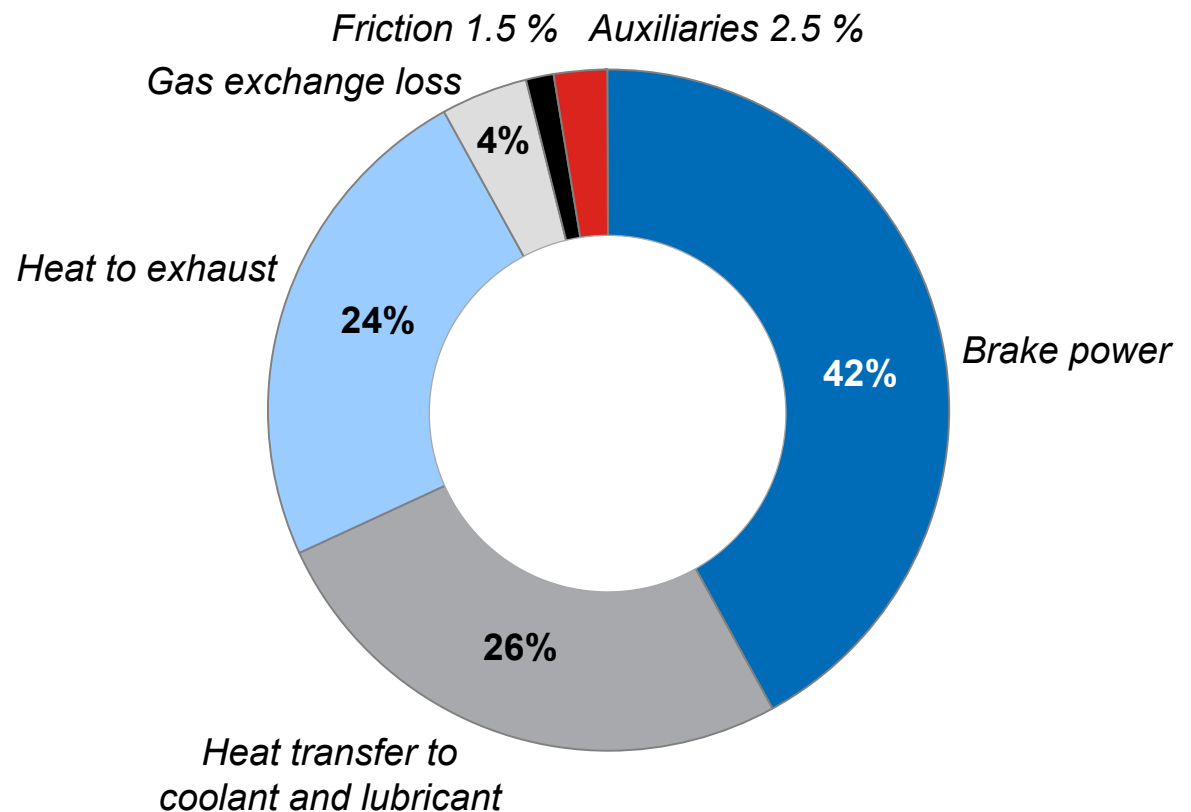

Engine efficiency improvement – Engine friction reduction leads to a relatively small improvement in CO₂ emissions



Technology Description

Component / System	Potential Improvement	Comments	Potential fuel consumption reduction
Lubricant viscosity specification	<ul style="list-style-type: none"> Reduction of oil viscosity; introduction of friction modifying additives 	<ul style="list-style-type: none"> Strategy successfully implemented in light duty applications - durability testing for heavy duty application 	1% ~ 2.4% ^{1) 2)3)}
Pistons, Rings, Liners	<ul style="list-style-type: none"> Piston: skirt optimisation (length, profile, surface, flexibility), mass reduction Piston rings: reduction in thickness and improvements ring tension Liners: improve roundness and surface through plasma coating 	<ul style="list-style-type: none"> Attention to design and materials specifications for components to minimise internal losses Technologies well-understood. Limited potential for improvement over current production components, if well designed 	0% ~ 0.5%
Crank System, Crankshaft design, bearing materials	<ul style="list-style-type: none"> Reduction of crankshaft bearing sizes, through use of high specification materials and manufacturing processes 	<ul style="list-style-type: none"> Limited scope for improvement, especially with demand for higher maximum cylinder pressures in future engines 	0% ~ 0.5%
Offset cylinder to crankshaft axis	<ul style="list-style-type: none"> Used by some manufacturers, such as Honda⁴⁾ 	<ul style="list-style-type: none"> Studies at Ricardo have shown benefits under some operating conditions, but no benefit at others. Overall benefit thought to be small. 	0% ~ 0.5%

* Notes: The potential to improve fuel consumption depends on the starting point.

The potential fuel consumption improvements cannot be added, as there may be an interaction between various technologies listed here

- Change to lower viscosity oils shows medium CO₂ reduction potential, but needs to prove durability behaviour

Source: 1) 0W-20 Fuel Economy HDDE Oil – The Ultimate Balance of Friction and Wear – Esslingen Jan 2008 – Infineum/Selenia/FPT/Iveco; 2) Study of future engine oil: future engine oil scenario Toyota; Nippon Oil Corporation SAE 2007-01-1977; 3) SAE 2000-01-1983 & SAE 2002-01-2768, BP; 4) The effect of crankshaft offset on piston friction force in a gasoline engine; Musashi Institute of Technology; SAE 2000-01-0922

Engine friction is well understood and improvements are possible even if the overall effect is relatively small

CO₂ Benefit

Engine friction – piston ring

- Reduction of piston ring thickness from 3 mm to 2.5 mm combined with a PVD coating on rings, with may give up to 1% reduction in engine friction
- Reducing ring tension (especially oil control ring)
 - Nissan/Renault claim to have significantly reduced piston ring tension (and so reduced engine friction by 6%) on a gasoline engine by machining the bores with a dummy cylinder head and gasket in place to provide equivalent head bolt loading and gasket pressure¹⁾. Only benefit with parent bore, most HDDE have wet liners.

Engine friction – piston skirt

- To minimise piston skirt friction loss
 - Minimise skirt length, optimise skirt profile make skirt more flexible (Nissan claim 0.5% improvement in fuel economy²⁾) and minimise piston skirt surface roughness and reducing piston mass
- Piston skirt coating
 - Screen printable coatings like AE 072 or Molykote D-10 can be applied on the piston skirt to improve the friction performance – estimates of friction reduction are ~1%
 - Honda claim a 3.2% reduction in engine friction compared with a conventional molybdenum coating³⁾ using a MoS₂ powder process

Engine friction - cylinder liner

- Plasma coated cylinder liners – Sulzer Metco claims ~3.5% reduction in engine friction⁴⁾

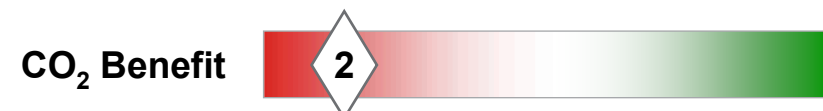

Source: 1) Effects 3-piece oil ring on oil consumption; Riken Corporation; Musashi IT Tamatutumi; Nissan Motor Co; Jan 2000, JSAE 20004008; 2) Development of a low friction piston with a new flexible skirt structure for a 3.5-l v6 gasoline engine; Nissan; UNISIA; SAE 2002-01-0491; 3) Research into surface improvement for low friction pistons; Honda R&D Co., Ltd; SAE 2005-01-1647; 4) Significant reduction of friction in cylinder bores for petrol and diesel engines; Sulzer Metco AG; EAEC Congress; June 2003

Engine friction is well understood and improvements are possible even if the overall effect is relatively small



CO₂ Benefit

Engine friction – crankshaft design

- Bearing diameter should be minimised, with potential ~1% improvement on engine friction, within constraints on the following
 - Peak specific load capability of bearing shells (use sputtered bearings if necessary)
 - Minimum oil film thickness
 - Crankshaft torsional vibration
 - Crankshaft strength (use best quantity steel)

Engine friction – crankshaft bearing surface finish

- Reducing bearing journal surface roughness
 - Nissan/Renault claim that crankshaft friction can be reduced by reducing journal surface roughness from 0.15 Ra to 0.02 Ra and claims 5% friction reduction on a light duty gasoline engine¹⁾
 - Assume a reduced benefit of 2% friction reduction for HDDE

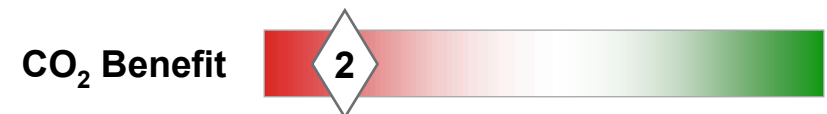

Engine friction is well understood and improvements are possible even if the overall effect is relatively small



CO₂ Benefit

Engine friction – crankshaft / cylinder off-set

- Crankshaft to cylinder axis off-set to reduce piston to cylinder load force and engine friction
 - Japanese engine manufacturers (Toyota, Honda and Nissan) have introduced engines with an offset between the cylinder axis and the crankshaft axis of 8-15 mm¹⁾
 - Ricardo and others have tried to quantify the benefit of this
 - Most sources agree that there is a small benefit at low engine speeds and high loads (so may give most benefit on diesel engine). Possibly up to 8% reduction in piston friction, or 3% reduction in engine friction under these conditions. At part load the benefit is probably less²⁾
 - For a new engine this measure is cost neutral but for an existing engine the cost is likely to be high

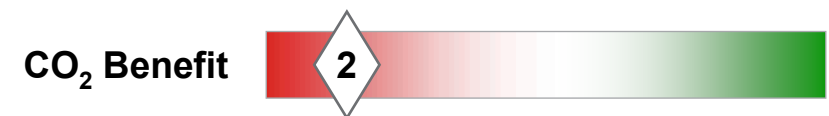

Engine friction is well understood and improvements are possible even if the overall effect is relatively small



CO₂ Benefit

Engine friction – lubricant viscosity specification

- Base engine friction can be reduced by the following changes to lubricants
 - Reduction of oil viscosity
 - Introduction of friction modifying additives
- Current heavy duty truck engines typically use 10W/40 or 10W/30 oil
- Oil suppliers data shows a potential average 2.4% improvement in fuel consumption (combined ETC cycle result) obtained by changing grade from 15W/40 to 5W/40 and using a synthetic base stock with viscosity improvers¹⁾²⁾
- A similar change tested on the US HD FTP cycle (greater proportion of high load) yielded 0.9-1.3% fuel consumption improvement.
- Viscosity grade isn't a consistent measure of the CO₂ reduction potential. For example¹⁾ :
 - 10W40 synthetic with specific viscosity additives leading to thinner oil films in the engine – 0.9% fuel consumption improvement
 - 5W40 synthetic – 0.4% fuel consumption improvement
- This means that oil grade specification is not a proxy or indicator for achievable CO₂ saving.

CO₂ Benefit



Increased powertrain and emissions control technology (ECT) costs to achieve competitive fuel consumption / CO₂ emissions



Technology and Environmental Cost

Technology

- Add on costs for engine friction reduction pack (incl. piston / -rings, cylinder liners; bearings and oil viscosity) estimated at ~ 2.6 % and 4.2 %
- Introduction of low friction technologies should be considered in new engine designs
- Relatively inexpensive solutions like change in piston ring design can be done for engines in production, however these changes may require costly durability validation
- Service cost / intervals may increase if changing to lower friction piston / - ring arrangements or lower viscosity engine oils

Environmental

- Some special coating materials (e.g. MoS₂ variations) can have additional risks such as water pollution and must be treated with care in production
- Reduction of oil viscosity might impact oil change intervals

Estimated Cost (£)	Medium Duty	Heavy Duty
Powertrain	£2,850	£6,000
ECT	£1,000	£1,500
TOTAL	£3,850	£7,500

Estimated cost % of total		
Piston, -ring, Liner package optimisation	3.1	1.8
Bearing design and coating optimisation	0.6	0.4
Lower lubricant viscosity specification	0.5	0.4
Crankshaft / cylinder axis off-set	0.0	0.0

Please note: Crankshaft / cylinder axis off-set for new engine design – cost neutral

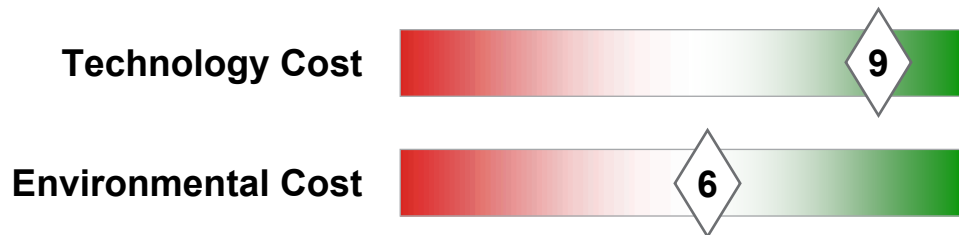

Engine friction reduction technology is limited by high medium and heavy duty durability requirements

Safety and Limitations

- ✓ Engine friction is well understood and technology for design and surface improvements is available
- ✓ Oil viscosity change might offer a good cost / benefit ratio
- ✗ Durability is very important for medium and heavy duty application – long term durability tests might be necessary
- ✗ Medium & heavy duty sector is very cost sensitive – increase in powertrain costs and service costs can make technology introduction difficult
- ✗ Crankshaft diameter reduction depending strongly on peak cylinder pressure load impact

Technology Maturity

- Technology available and relatively mature for light duty applications
- Most technologies should be feasible for heavy duty applications if does not affect durability

Safety and Limitations



Maturity

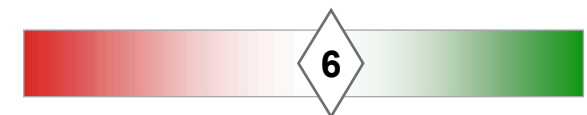

Optimisation or electrification of engine accessories has potential to reduce CO₂ emissions for medium and heavy duty applications



Controllable air compressor

- **Concept:** Electric clutch – air compressor
- **Base Functioning:** Air compressor with electric / air actuated clutch to de-connect compressor in idle status or when compressor not required
 - Current truck airbrake systems simply dump excess pressure to ambient when the air tanks are full, the compressor keeps running
 - For long-haul truck work, the airbrake system may not be used for up to 90% of the time
- **CO₂ Benefit:** Average of 1.5 % CO₂ reduction
- **Costs:** Increasing costs – electric clutch and control system

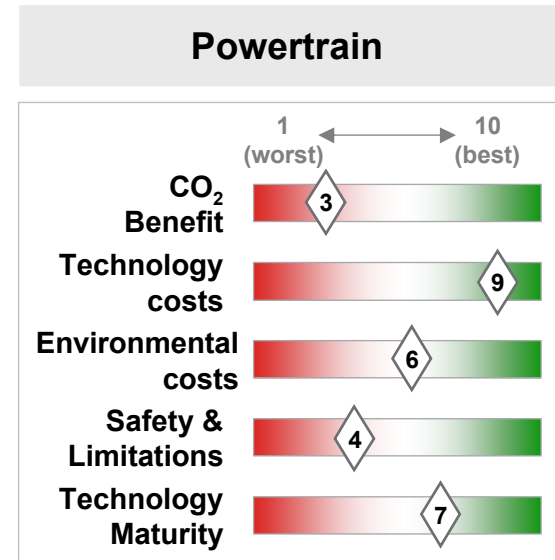

Safety and Limitations

- ✓ Medium potential reduction in fuel consumption and CO₂ emissions
- ✓ Can be used with existing engine design
- ✗ Increased costs
- ✗ System must be fail safe

Technology Applicability

- Available for heavy duty application and in series production (MAN)
- Medium duty applications possible – might be less effective (more stop / start scenario)

Visualisation



Picture: Transport Engineer, Every little helps, Nov 2008

Electric clutch for an air compressor de-connects in compressor idle situations and reduces compressor power consumption



Technology Description – Air compressor electric clutch

- Air compressors essential for vehicle operation:
 - Vehicle service brakes
 - Parking brake release
 - Air suspension
 - Auxiliaries (bus doors, etc.)
- Most demand occurs under urban and low speed operating conditions (more medium duty application)
- Greatest parasitic losses under cruising conditions – high potential for heavy duty trucks
- An electrically actuated clutch to de-couple the compressor will reduce losses, even under idling conditions
- MAN is using an air-operated multi-plate clutch in between compressor crankshaft and engine (APM system – air pressure management)
- Compressor can be disconnected for up to 90 % of the time, on highway drives with little brake work

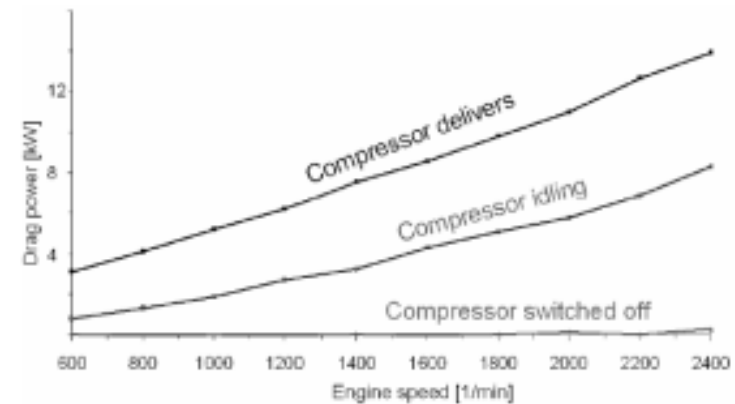

Drag Power Compressor with Shut-off Clutch

Picture: Schaller K V, MAN, Aachen 16 Kolloquium, 2007

CO₂ benefit can be around 0.5 litre in 100km – around 1.5 % CO₂ reduction at heavy duty applications



CO₂ Benefit

Electric clutch air compressor

- MAN first mentioned this technology in 2007 and quoted the potential of fuel reduction with around 0.5 litre/100 km¹⁾
- MAN introduced technology in 2008 and CO₂ reduction of ~ 1.5 % can be achieved²⁾
- Knorr-Bremse EAC2 system intelligently switches the compressor to do more work under vehicle overrun conditions and less work when the engine is working hard. On Mercedes Actros, claims 2% fuel economy improvement over a typical year's operation²⁾



Picture: Transport Engineer, Every little helps, Nov 2008

CO₂ Benefit



Clutched air compressor technology can increase powertrain and emissions control technology (ECT) costs by around 1 %



Technology and Environmental Cost

Technology

- Adding costs on air compressor system for electronic or air actuated clutch and control system
- Costs for a standard air compressor are ~ 1 % to 2 % of powertrain and ECT
- Estimated additional costs for a clutched compressor are likely to be ~1 %

Estimated Cost (£)	Medium Duty	Heavy Duty
Powertrain	£2,850	£6,000
ECT	£1,000	£1,500
TOTAL	£3,850	£7,500

Estimated cost % of total		
Standard air compressor	2.0	1.0
Air compressor + electric clutch	3.1	2.1

Environmental

- The environmental impact of a clutched air compressor compared to a standard system are likely to be minor. Additional components, slightly increased manufacturing and additional materials for the clutch system can cause an effect in terms of CO₂ emissions due to manufacturing and resourcing. Declutching the compressor rather than venting should have a small noise benefit.

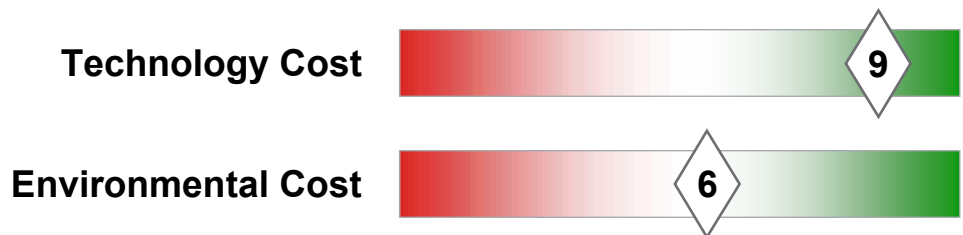

The technology has few safety or vehicle application limitations and is a relatively mature product and introduced to the market

Safety and Limitations

- ✓ Technology is more effective for heavy duty application – highway drives with limited brake usage
- ✗ In medium duty scenarios, like delivery routes with start / stop, have less compressor idle time
- ✗ Compressor clutch must fail safe to eliminate risk of brake pressure depletion

Technology Maturity

- MAN technology since 2008
- MAN and Mercedes appear to be lead major OEMs using clutched air compressor technology

Safety and Limitations

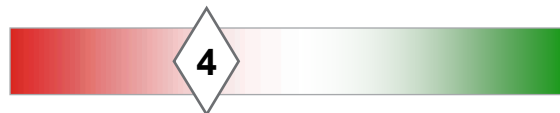

Maturity



Optimisation and electrification of engine accessories have potential to reduce CO₂ emissions for medium and heavy duty applications



Accessories – Oil pump

- **Concept:** Oil pump – variable speed pump or electric oil pump
- **Base Functioning:** Oil flow amount adjusted to engine speed and requirement to optimise oil flow and oil pump power consumption
- **CO₂ Benefit:** Fuel consumption / CO₂ improvements 1-3% possible
- **Costs:** Increasing costs – advanced oil pump technology and control systems

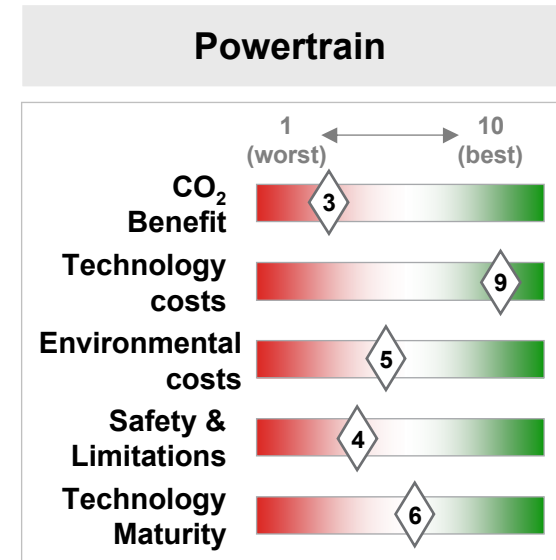

Safety and Limitations

- ✓ Moderate potential reduction in fuel consumption and CO₂ emissions
- ✓ New engine designs
- ✓ No impact of vehicle safety for mechanical variable flow pumps providing they fail safe
- ✗ Applicability to existing engines
- ✗ Durability concerns with full electric oil pumps
- ✗ Increased costs

Technology Applicability

- Variable speed pumps available and in production medium and heavy duty vehicles
- Electric oil pumps not in series production
- Demonstrator and reasearch projects

Visualisation

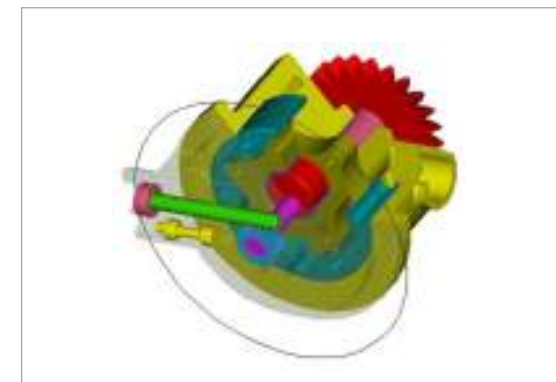

Picture: www.concentric-pump.co.uk

Variable speed and electric oil pumps altering the oil flow depending on engine speed and reducing parasitic losses



Technology Description

- Standard oil pumps are specified for oil flow at low engine speeds and therefore are over-sized for higher engine speeds
- Mechanical variable oil pump
 - Oil flow adaption on engine speed and hence reduction on power required by oil pump
 - 2 speed oil pump – less oil flow at high engine speed
 - Continues variable speed pump – decreasing oil flow with increasing engine speed, where pump control can be mechanical or electronic
- Further benefits can be achieved with a controllable oil pump if controllable piston cooling jets are included to limit flow at part load
- Electric oil pump
 - Fully variable oil flow depending on engine speed
 - Might require 42v electrical supply
 - Pre and post operation lubrication to minimise wear and protect turbocharger
 - Improved options for packaging

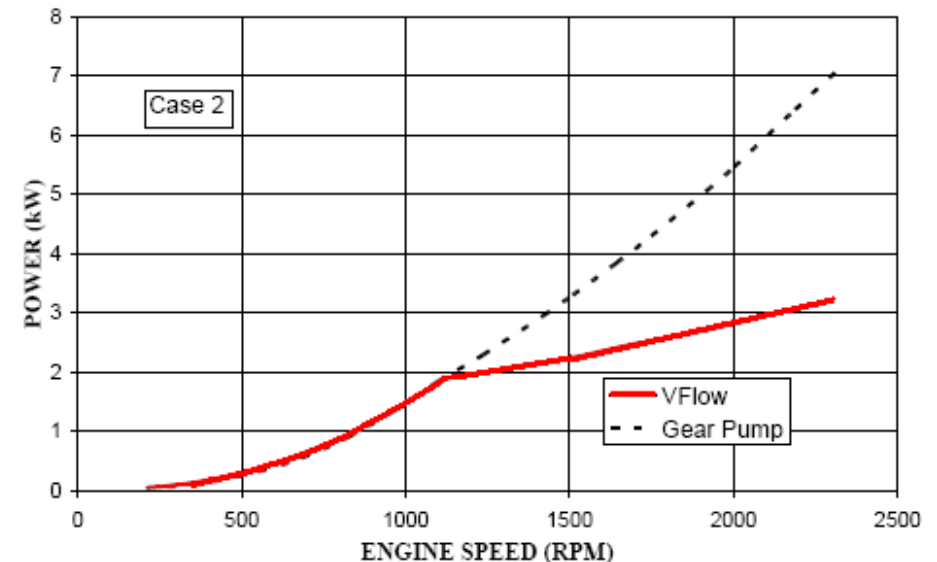

Power consumption standard gear pump and variable flow pump
Source: www.concentric-pump.co.uk

Average CO₂ benefit estimated to be around 1.5% for heavy duty applications, but considered to be less for medium duty HGV



CO₂ Benefit

Oil pump – variable flow

- Concentric claims variable flow oil pumps can save 1-3% in fuel economy
- Concentric's latest variable flow pump (VFP) - heavy-duty diesel it is said to reduce 'pumping losses' by as much as 4hp at rated speed and typically by 1hp under cruise conditions, with resulting reductions in fuel usage of up to around 0.6%
- CO₂ benefits will depend on drive cycles and HGV applications
 - Less potential for medium duty HGV – drive cycle with more time in lower engine speed / load area, where standard oil pumps operating already close to optimum
- Electric oil pumps only used in racing application. In a conservative marketplace, there will be strong concerns about risk to engine integrity should an electric pump fail

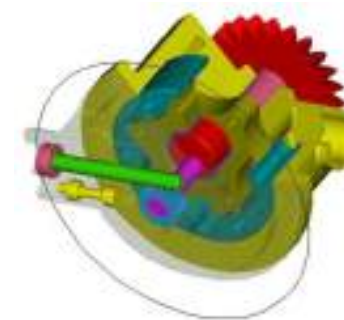

Variable displacement oil pump
Source: www.concentric-pump.co.uk

CO₂ Benefit





Advanced oil pump technology can increase powertrain and emissions control technology (ECT) costs by up to ~3 %

Technology and Environmental Cost

Technology

- Standard mechanical oil pump is are 0.2 % to 0.4 % of powertrain and ECT costs (medium and heavy duty)
- Increasing technology costs by going from standard oil pumps to variable flow (2 stage), continuously variable flow and electric oil pumps
- Additional costs to up-date to an mechanical oil pump can be up to ~3 % of powertrain and ECT cost for a fully electric operating pump

Estimated Cost (£)	Medium Duty	Heavy Duty
Powertrain	£2,850	£6,000
ECT	£1,000	£1,500
TOTAL	£3,850	£7,500

Estimated cost as % of total		
Mechanical oil pump	0.4	0.2
Variable mechanical oil pump	1.6	0.9
Electric oil pump	3.4	2.3

Environmental

- The environmental impact of a variable oil pump compared to a standard system are likely to be minor. Additional components, slightly increased manufacturing and additional materials for the control system can cause an effect in terms of CO₂ emissions due to manufacturing and resourcing.

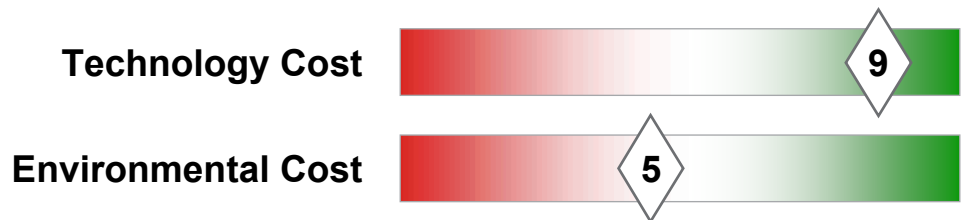

Variable oil flow technology should not have safety limitations if specified correctly, however electric pumps are not fail-safe yet

Safety and Limitations

- ✓ Correct specification mechanical variable oil pumps
- ✓ Implementing in new engine design
- ✗ Up-dating existing engine designs might be more challenging
- ✗ Electrical failure on electric oil pumps with serious engine damage

Technology Maturity

- Mechanical variable oil flow pumps available for heavy and medium duty applications. Expected SOP 2012
- Electric oil pumps are mentioned in SAE papers and manufacturers are interested, but durability and engine safety preventing a market introduction so far

Safety and Limitations

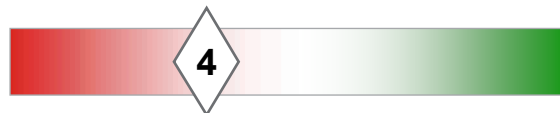

Maturity

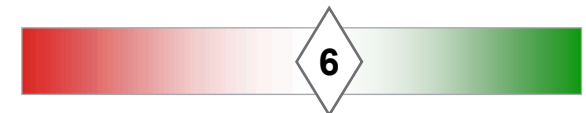

Optimisation and electrification of engine accessories has potential to reduce CO₂ emissions for medium and heavy duty applications



Variable flow water pump – electric water pumps

- **Concept:** Variable coolant flow depending on engine speed / load condition
- **Base Functioning:** Mechanical variable flow and electric water pumps vary pump speed, hence coolant water flow according to the engine demand
- **CO₂ Benefit:** Estimated 0.7% improvement in fuel economy / CO₂ emissions with variable flow water pump (mechanical) and about 1% - 4% with an electric water pump
- **Costs:** Increasing costs for both pump types

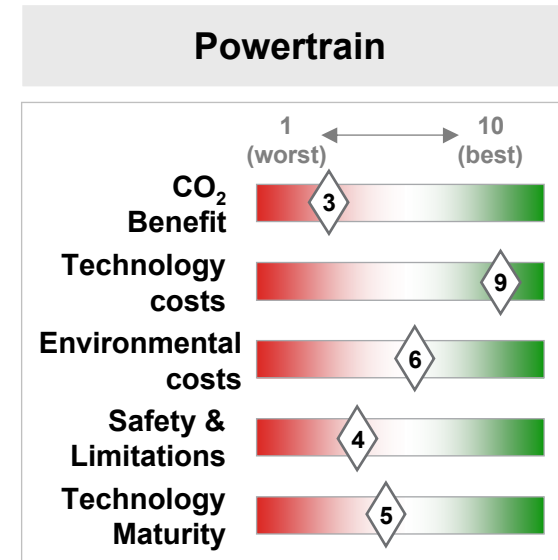

Safety and Limitations

- ✓ Medium potential reduction in fuel consumption and CO₂ emissions
- ✓ Up-date on existing designs with mechanical variable flow pumps
- ✓ No impact of vehicle safety
- ✗ Fully electric pumps for new engine designs
- ✗ Increased costs
- ✗ Pump must fail safe

Technology Applicability

- Available for heavy duty application and intended for production in 2009 by Mercedes (mechanical variable flow pumps)
- Medium duty applications may acquire technologies from light duty sector

Visualisation

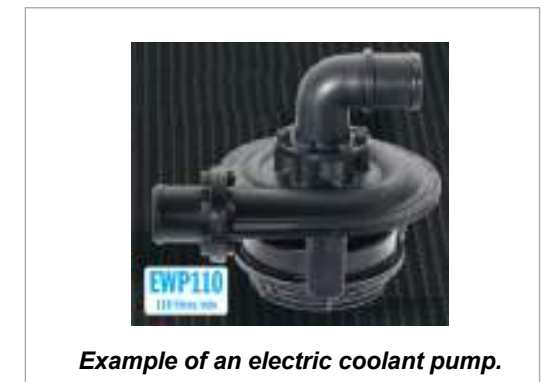

Picture: www.daviescraig.co.au

Mechanical variable and electric water pumps with optimised coolant flow depending on engine speed



Technology Description

- Engine coolant flow control depending on engine speed and demand
- Standard mechanical water pumps are sized for lower engine speeds to guarantee enough coolant flow at this critical condition
- For higher engine speeds is the water pump over-sized and delivers to much flow
 - Variable flow pump can save power by adjusting the flow
 - Coolant flow can be optimised to required flow for optimum coolant heat exchange – engine efficiency
 - Variable water pump is likely to benefit applications running at higher power
- Mechanical variable flow water pump
 - Water pumps with two speed mechanism – reduced pump speed for high engine speed
 - Continuously variable mechanical flow pump – reducing pump speed continually with increasing engine speed
 - Pump control can be mechanical or electronic
 - Variable slip belt drive is in production on passenger car (BMW/PSA)
 - Variable magnetic coupling
- Electrically driven water pump
 - Fully variable flow rate to engine requirements
 - Eliminating need for water pump drive and free packaging

Picture: BMW/PSA variable belt tensioner



Mechanical variable flow and electric water pumps have the potential to reduce CO₂ emissions by around 1% to 4%



CO₂ Benefit

Electric water pump

- Water pump with variable speed control to deliver coolant flow rates for different engine demands (Mercedes Actros – intended for 2009) – expected fuel economy benefit ~0.7%¹⁾
- Davies Craig recently claimed that use of an electric water pump can improve fuel economy of 5L-8L V8 by 4%²⁾
- Pierburg claims a fuel economy improvement of up to 3% by using electric water pumps in the vehicle coolant system (BMW, passenger car)³⁾
- Potential CO₂ benefit 1-3% depending on medium and heavy duty application
- Heavy duty benefits expected to be higher than medium duty – application, but will depend on duty cycle and specifically engine operating speed range



Picture: Electric water pump
Automotive Engineer, Wilkinson 2004 ¹⁹⁾

CO₂ Benefit



Source: Ricardo Research, Ricardo Evaluation; www.daviescraig.co.au; 1) Transport Engineer, Every little helps, Nov 2008; 2) Pumping power; autoasia, Nov/Dec 2005; 3) <http://www.kspg-ag.de> Electrical coolant pumps; May 2009

Advanced coolant system technology can bring possible improvement in emissions with minimal powertrain on cost

Technology and Environmental Cost

Technology

- Common standard mechanical water pumps are around 0.3 % to 0.5 % of the overall powertrain + ECT costs, depending on medium or heavy duty
- Additional costs for variable mechanical water pumps are estimated to an increase by 0.4 % to 0.8 % per pump, including costs for the control unit
- Especially for electronic coolant pumps costs are raising up to 1.1 % to 1.9 % of powertrain and ECT costs and that is a significant cost increase for one engine component
- Improving engine life – elimination of engine heat soak through pump after run

Estimated Cost (£)	Medium Duty	Heavy Duty
Powertrain	£2,850	£6,000
ECT	£1,000	£1,500
TOTAL	£3,850	£7,500

Estimated cost as % of total		
Coolant pump	0.5	0.3
Variable mechanical flow water pump	1.3	0.7
Electric water pump	1.9	1.1

Environmental

- Electric water pump
 - Possible improvement in emissions with higher engine coolant temperatures and better cold start behaviour

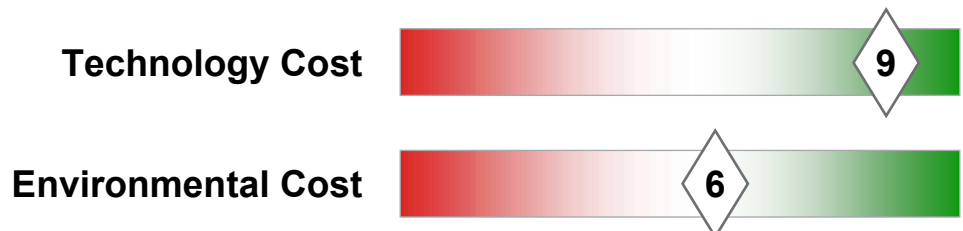

Variable coolant flow technology should not have safety limitations if specified correctly, however electric pumps need fail-safe mode

Safety and Limitations

- ✓ System mature for medium duty applications
- ✓ Mechanical variable flow pumps considered to be durable
- ✗ Durability for electric components
- ✗ Engine damage in case of component failure
- ✗ Failure back-up system for electric components

Technology Maturity

- Medium and heavy duty manufacturers using mechanical variable water pumps
- Electric water pumps are more common in light duty sector
- Davies Craig and Pierburg are two suppliers manufacturing electric water pumps

Safety and Limitations

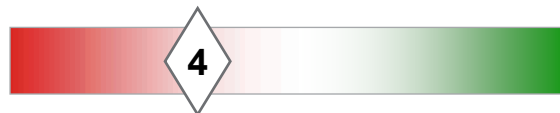

Maturity



Air hybrid systems have potential to reduce CO₂ emissions by using the brake air reservoir to store energy



Air hybrid system – Pneumatic booster system (PBS)

- **Concept:** Compressed air to inject in air system
- **Base Functioning:** Compressed air from vehicle braking system injected rapidly into the air path and allows a faster vehicle acceleration, which allows an earlier gear shift (short shifting). Engine operates more in efficient engine speed / load range
- **CO₂ Benefit:** ~1.5-2% CO₂ reduction claimed, will depend on base engine BSFC map characteristic, ability of system to support repeated short shifts and efficiency of generating compressed air in the first place
- **Costs:** Expected moderate cost increase

Safety and Limitations

- ✓ Medium potential for CO₂ reduction
- ✓ System demonstrated on buses and trucks
- ✗ System must not risk loss of air from brakes
- ✗ Boost limitations on air system (regulating to maximum boost limit)
- ✗ Air compressor with higher capacity
- ✗ Larger air reservoir tank

Technology Applicability

- PBS system developed by Knorr-Bremse
- Series production expected to start 2011

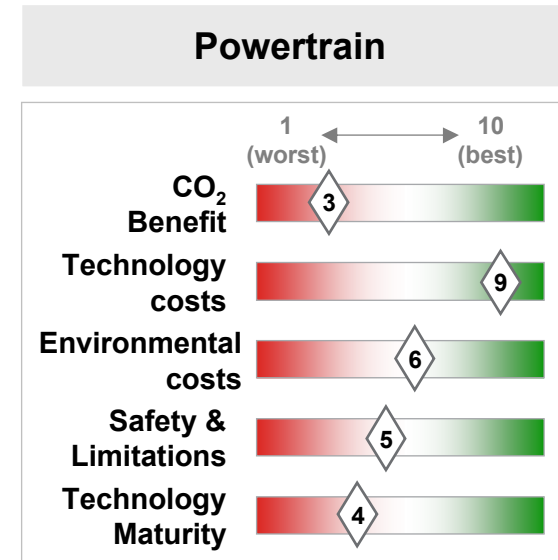

Visualisation



Picture: Knorr-Bremse PBS system; Knorr-Bremse; 29th IWM, 2008¹⁾

Knorr-Bremse pneumatic booster system allows engine operation in more efficient operating range over a longer time



Technology Description

- Knorr-Bremse pneumatic booster system (PBS)
 - Air compressor with ~50 % more capacity, electronic system control, larger air reservoir
 - Compressed air from vehicle braking air system
 - Rapid injection of stored air under pressure in inlet manifold, controlled by electronic pedal signal
 - Faster acceleration and earlier shifting in next higher gear at lower engine speeds
 - Engine operates longer in more fuel efficient engine speeds / load range
 - Air hybrid boost system might offer potential for engine downsizing and further fuel and CO₂ reduction possibilities

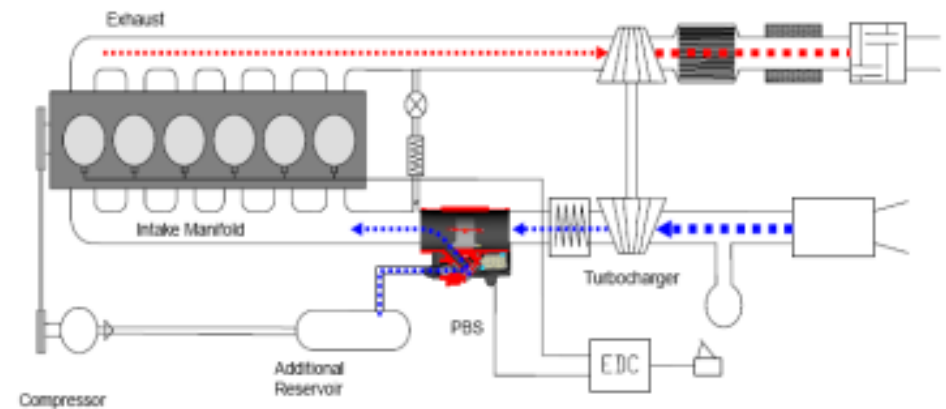

Picture: Knorr-Bremse PBS system; Knorr-Bremse; 29th IWM, 2008 ³⁰⁾

Pneumatic boost system can improve CO₂ emissions by up to 2% and can be further optimised with linked gear shift strategy

CO₂ Benefit

- Knorr-Bremse pneumatic booster system (PBS)
 - CO₂ improvements of 1.5 – 2% are claimed by Knorr-Bremse¹⁾
 - Additional benefits are possible if an automatic gear shift system takes PBS into the shift strategy
 - expected CO₂ reduction 3 – 7%¹⁾
- These claims need to be balanced by the impact of increased compressor power consumption. The real world impact of this would depend on the duty cycle. For instance, coupled with EAC2 intelligent compressor, air system recharge could be done on overrun if duty cycle permits. Otherwise, system will be recharged by consuming engine power at the rates seen in the “Air compressor” section of the report
- The reality is that the achievable CO₂ benefit is strongly dependent on the duty cycle. As such Ricardo believe a more realistic real world benefit would be 1.5 – 2% maximum

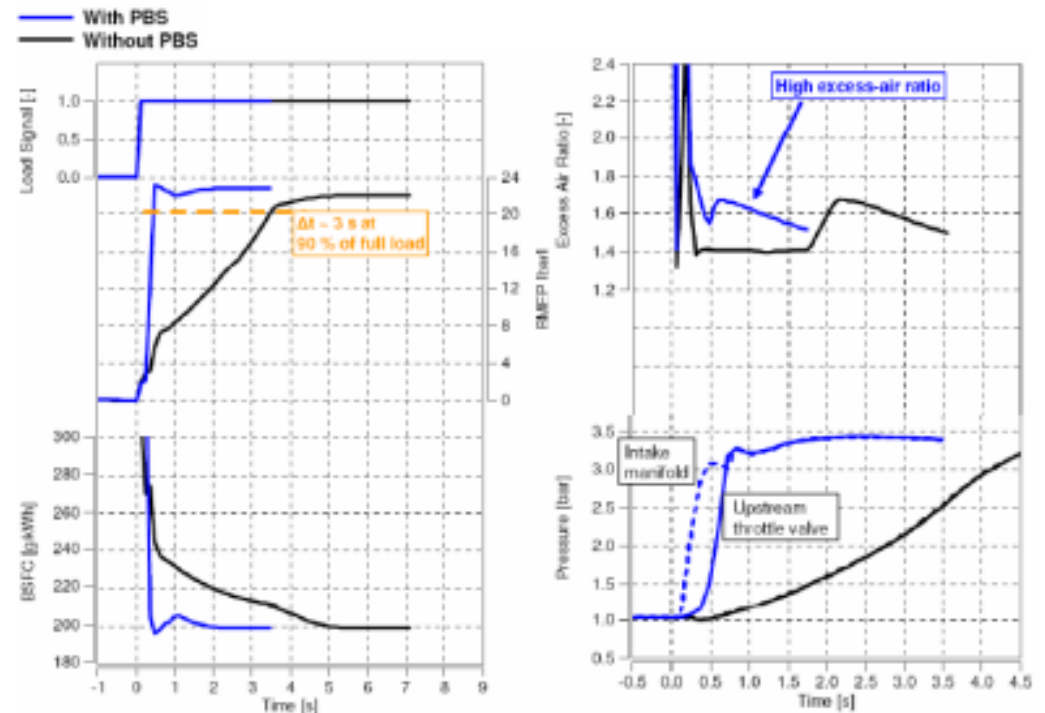

Picture: Tested PBS system at 1000rpm load response (blue PBS ON – black PBS OFF) Knorr-Bremse; 29th IWM, 2008 ³⁰⁾

CO₂ Benefit

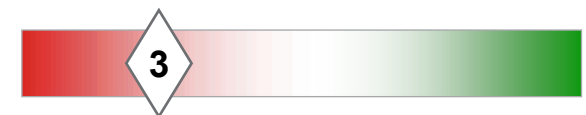

Air hybrid technology can increase powertrain and emissions control technology (ECT) costs by up to ~ 1 %



Technology and Environmental Cost

Technology

- Additional costs for air compressor with higher capacity, electronic control unit, larger air reservoir tank
- Depending on heavy and medium duty, the powertrain and ECT cost increase is estimated around 0.6 % to 1.1 %

Estimated Cost (£)	Medium Duty	Heavy Duty
Powertrain	£2,850	£6,000
ECT	£1,000	£1,500
TOTAL	£3,850	£7,500

Estimated cost as % of total		
Est. add-on cost of air hybrid system	1.1	0.6

Environmental

- The air hybrid system offers an improvement transient engine responds and will reduce vehicle emissions during acceleration and hill climbing. The overall emitted emissions will reduce.
- The environmental impact of a air hybrid system (similar to PBS) compared to a standard system is likely to be minor. Additional components, slightly increased manufacturing and additional materials can cause an effect in terms of CO₂ emissions due to manufacturing and resourcing

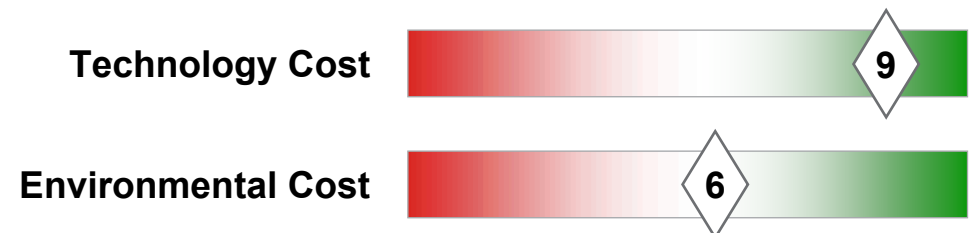

Boost pressure hybrid systems are being demonstrated on HGVs



Safety and Limitations

- ✓ Minimising turbo boost lag at acceleration
- ✓ Downsizing potential with power increase via boost hybrid system
- ✓ Improving driving comfort due to less shifting
- ✗ Boost limitations on air system (regulating to maximum boost limit) – air system specification
- ✗ Air compressor with higher capacity might reduce fuel consumption benefits
- ✗ System must not risk depleting air brake circuit

Technology Maturity

- PBS system developed by Knorr-Bremse
- Test buses and trucks running with new system
- Series production expected to start 2011

Safety and Limitations



Maturity

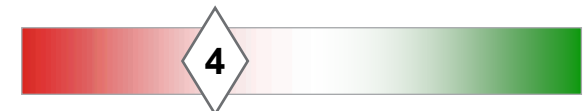

Gas exchange improves engine efficiency and has potential to improve CO₂ emissions

Gas exchange – Efficiency Improvement

- **Concept:** Improvement engine efficiency via less gas exchange losses
- **Base Functioning:** Combination of technologies to increase fresh air and exhaust gas exchange rate and lowering the exhaust backpressure:
 - Two stage turbocharging
 - Electric assisted turbocharger increase the fresh air intake over the speed range
 - Variable valve train, adjusting valve timing to engine speed
 - Long route EGR or EGR pump, which also increases energy available to turbocharger
- **CO₂ Benefit:** Up to 2 % CO₂ reduction
- **Costs:** Expeceted high cost increase for technology package

Safety and Limitations

- ✓ Two stage turbocharging established in the market
- ✓ VVT required for HCCI combustion systems
- ✗ Cost and durability EGR pump and electrical valve actuation systems
- ✗ Lower engine speed range on heavy duty engines – less efficient for VVT
- ✗ Power source for electric motor
- ✗ Air system specification driven by emissions

Technology Applicability

- Two stage turbocharging mature
- Heavy duty VVT systems in research phase
- Electrical assisted turbochargers researched in light duty field
- EGR pump in research / development status

Source: Ricardo Research, Ricardo Evaluation – Full sources available on detail slides in the attached annex

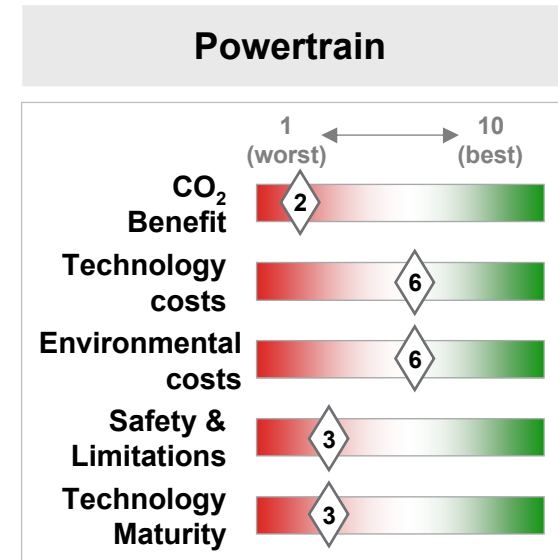

Visualisation

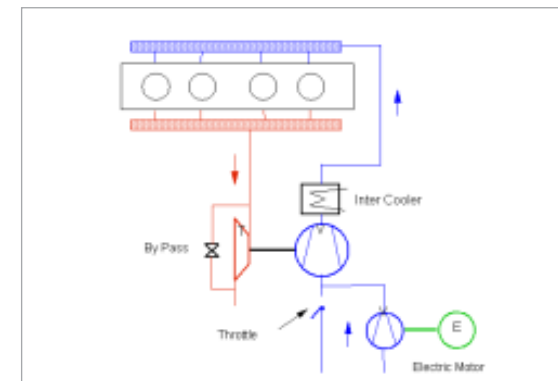

Picture: Electric assisted turbocharger
Source: www.3k-warner.de

Engine efficiency improvement – Fuel energy balance heavy duty engine: Engine gas exchange takes up ~4 % of the energy

Technology Description

- Typical engine energy balance US 2007
- Improvements in gas exchange efficiency results as only very small improvements in overall fuel consumption or benefits in CO₂ emissions reduction
- 50 % gas exchange improvement (to 2 %) equals a brake power benefit of 4.8 % (assuming all other losses are constant)
- However real-world implementations of technology are likely to achieve closer to 2%

HD Engine: Distribution of fuel energy at full load

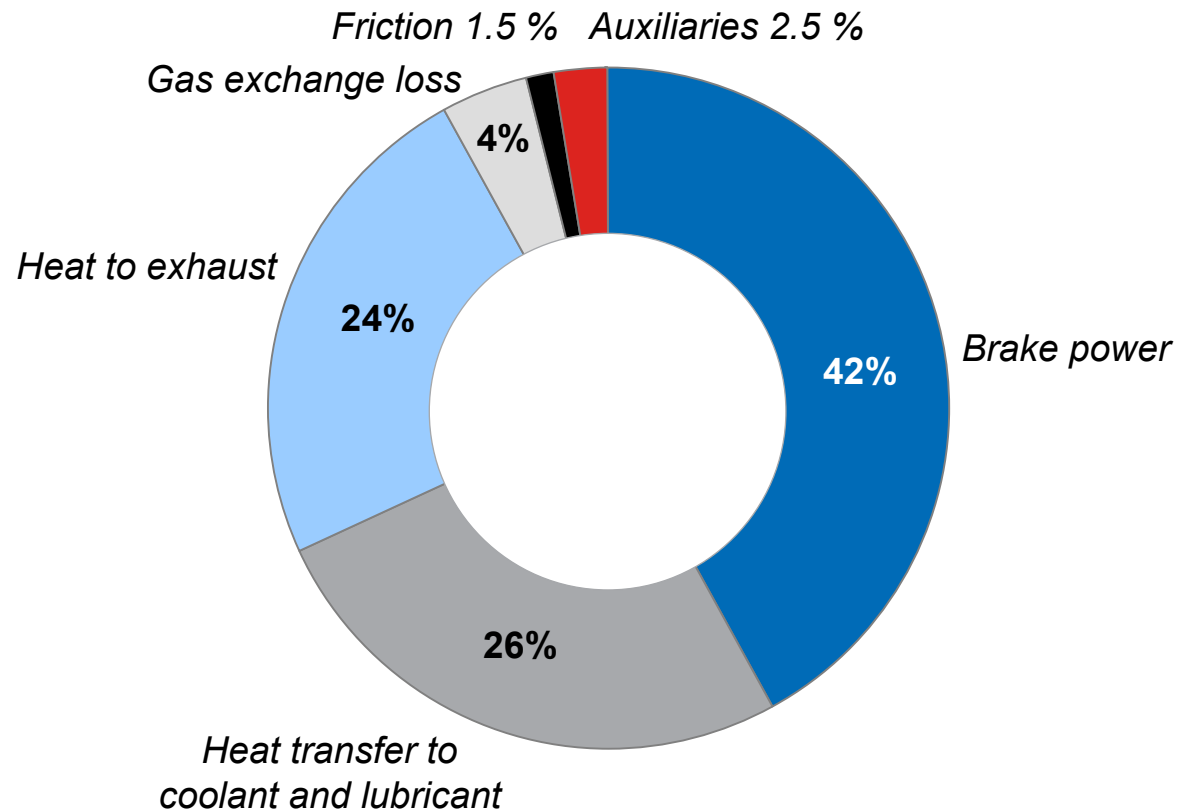

Improving the gas exchange efficiency with e-Turbo, VVT and EGR pump is a major technology up-grade



Technology Description

- Electrical assisted turbocharger
 - Electric motor powers additional or existing compressor and increases pressure output
 - Engine torque increase up to 40 % at lower engine speeds – potential for fuel consumption improvement¹⁾
 - Limited by vehicle electrical network/stored energy
- Variable valve train
 - High fuel consumption benefits for mechanical and electric / hydraulic valve trains for non turbocharged gasoline engines - up to 10-12 %²⁾
 - Turbocharged Diesel engines have no requirement for improved engine breathing so benefit minimal
 - VVT may be required to enable advanced combustion strategies such as HCCI, enabling low engine out emissions. This may offer a CO₂ benefit via deletion of aftertreatment but is not mature
 - Mechanical systems controlled by variable cam profile
 - Camless systems using hydraulic or electric actuators can have significant energy consumption
- EGR pump/long route EGR
 - Remote EGR circuits, independent from high exhaust pressures for high EGR rates
 - Increases turbine efficiency and can improve fuel consumption
 - Conflict between power required for EGR pump and turbine efficiency improvement
- Two stage turbocharging
 - Needed to support the high EGR rates for future emissions compliance on high power engines
 - Generally results in an improvement in gas exchange efficiency, since real world operation is close to the high efficiency “sweet spot” of one of the two turbocharger stages
 - Likely benefit ~2%

Reducing gas exchange losses by 2 %, increases brake power engine output and can improve CO₂ emissions by up to 5%

CO₂ Benefit

- Sources claim a potential reduction in gas exchange losses by 2 % when using¹⁾ :
 - Variable valve train
 - EGR pump
 - Electric assisted turbocharger
- Improvement of engine efficiency by 2 % can improve CO₂ emissions by almost 5 %
- Real world cost-effective technology package likely to achieve closer to ~2% CO₂ benefit
- Many of the gas-exchange technologies will be added anyway as emissions limits tighten, so technology is not a good indicator of potential CO₂ benefit

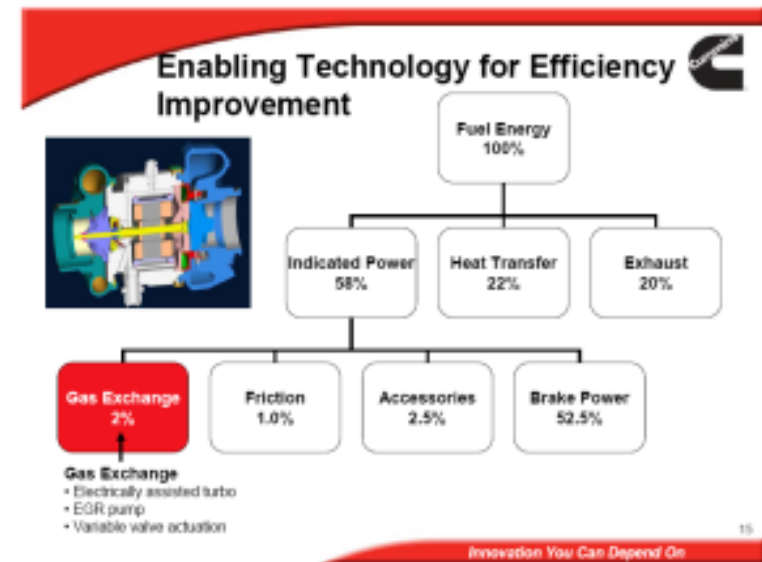

Picture: (29) Eckerle (Cummins) DEER paper 2007

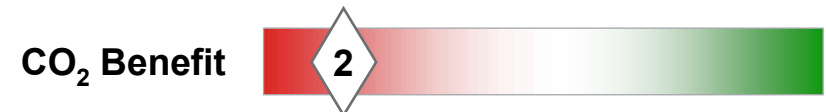

Source: 1) http://www1.eere.energy.gov/vehiclesandfuels/pdfs/deer_2007/session2/deer07_eckerle.pdf; DEER 2007

Technology cost increase to improve engine gas exchange are relatively high and technologies are complex

Technology and Environmental Cost

Technology

- Cost increase to improve CO₂ emissions by reducing gas exchange losses (compared to baseline powertrain + ECT costs)
 - Electric assisted turbocharger: + 2.1 % to 4 %
 - Variable valve actuation: + 0.8 % to 1.6 % (per cam)
 - EGR pump: + 0.9 % to 1.7 %
- Total cost increase to the baseline and for all three technologies sums up to 3.8 % to 7.3 % depending on heavy or medium duty
- Not all of these costs are directly attributable to CO₂ benefit, as many would be applied for emissions compliance reasons

Estimated Cost (£)	Medium Duty	Heavy Duty
Powertrain	£2,350	£6,000
ECT	£1,000	£1,500
TOTAL	£3,850	£7,500

Estimated cost as % of total		
Turbocharger	6.4	3.3
Electric assisted turbocharger	10.4	5.4
Camshaft	1.6	0.8
VVT – Camshaft (one)	3.2	1.6
EGR Valve + actuator	1.0	0.5
Electric EGR pump	2.7	1.4

Environmental

- E-turbo improvement in transient engine / vehicle responds, hence emissions reduction with vehicle acceleration (soot)
- E-turbo and VVT system are adding to manufacturing process

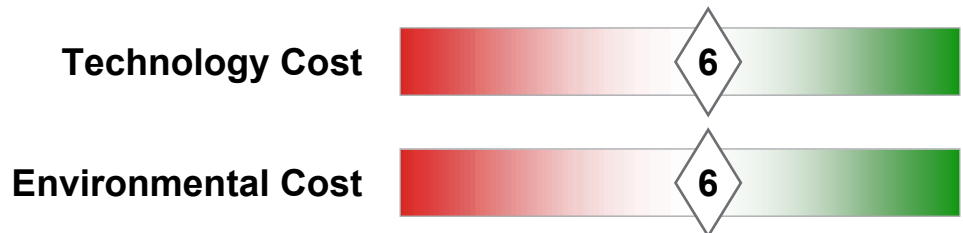

Gas exchange improvement technologies (VVT, E-turbo, EGR pump) are not implemented in HGV



Safety and Limitations

- ✓ Two stage turbocharging established in the market
- ✓ VVT required for HCCI combustion systems
- ✗ Cost and durability EGR pump and electrical valve actuation systems
- ✗ Lower engine speed range on heavy duty engines – less efficient for VVT
- ✗ Power source for electric motor – high voltage?
- ✗ Air system specification driven by emissions

Technology Maturity

- Two stage turbocharging already in the market
- Heavy duty VVT systems in research phase
- Electrical assisted turbochargers also researched
- EGR pump in research / development status
 - Mentioned around 2004 / 2005 and intended for production around 2008 / 2009, but so far no series production¹⁾

Safety and Limitations



Maturity



- **Feasibility Analysis**
 - Vehicle Technologies
 - **Powertrain Technologies**
 - Engine Efficiency
 - **Waste Heat Recovery**
 - Alternative Powertrains
 - Transmissions
 - Fuel Technologies

Waste heat recovery with moderate potential for CO₂ reductions – exhaust recovery systems: Turbocompound mechanical drive



Waste recovery systems – mechanical turbocompound

- **Concept:** Exhaust gas energy recovery
- **Base Functioning:** Exhaust gas energy recovery with additional exhaust turbine, which is linked to a gear drive and transfers the energy on to the crankshaft providing extra torque.
- **CO₂ Benefit:** Overall fuel economy benefit of 3-5% achievable¹⁾
- **Costs:** Increasing costs for turbocompound system

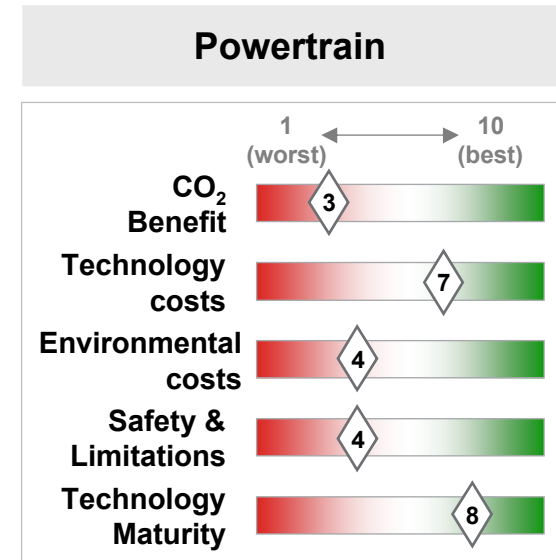

Safety and Limitations

- ✓ Medium to high potential in reduction of fuel consumption and CO₂ emissions
- ✓ Primary for new engine designs
- ✓ No impact of vehicle safety
- ✗ Complicated gear drive (turbine, engine speed difference)
- ✗ Increased costs

Technology Applicability

- Available for heavy duty application (Scania, Volvo, Detroit Diesel)
- Fuel / CO₂ benefits confirmed
- Medium duty applications not in production and benefits might be less significant depending on drive cycle

Visualisation



Picture: Scania turbo compound system Source: www.scania.com

Source: Ricardo Research, Ricardo Evaluation; 1) http://www.theicct.org/documents/Greszler_Volvo_Session3.pdf Turbocompound; Presentation ICCT / Volvo Feb 2008 – Full sources available on detail slides in the attached annex

Turbocompound mechanical drive with medium/high CO₂ reduction potential at higher engine loads



Technology Description

- Turbocompound – Mechanical drive
 - Exhaust turbine geared to the crankshaft
 - Engine speed dependent
- Higher power output
- Improvement engine responds and driveability
- Higher EGR rates achievable through increase exhaust backpressure with additional turbine in exhaust system
- Mechanical turbo compounding has been used in a number of engines
 - Largest volume of sales: Scania DT12
 - Most recent: Detroit Diesel DD15
- Potential for up to 5% improvement in fuel consumption at high loads & speeds
- Disadvantages:
 - No improvements in fuel consumption at low loads and speeds (may increase fuel consumption due to losses)
 - System adding weight, costs and complexity
 - Negative impact on aftertreatment systems (DPF regeneration and NOx reduction efficiency)
- Heavy duty engines with mechanical turbocompound systems are offered by some manufacturers, but the system is unlikely to provide real world benefits for light and medium duty engines

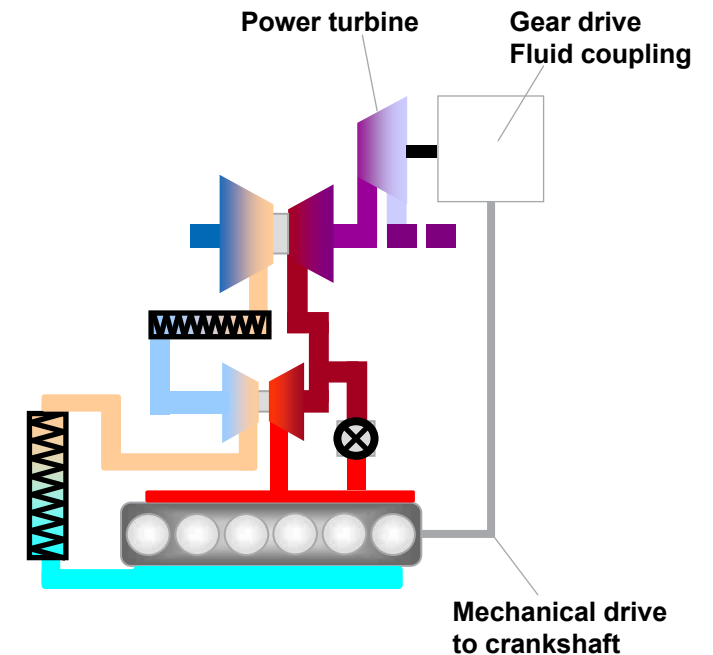

Mechanical turbocompound systems have benefits at medium and full load conditions and improve CO₂ emissions up to 5%



CO₂ Benefit

Mechanical turbocompound

- Potential CO₂ benefit 3-5% for heavy duty applications claimed by Volvo for a 400hp engine with turbocompound technology¹⁾
- Detroit Diesel DD15 – up to 5% CO₂ / fuel economy improvement with turbocompound, advanced injection system and optimised cooling compared to the series 60²⁾
- CO₂ benefit maximised on applications with long periods at high power. For a typical UK truck duty cycle (cross-country/highway mixed cycle), engine power is 25% of maximum power and so benefits will be proportionally less, say 1.5%

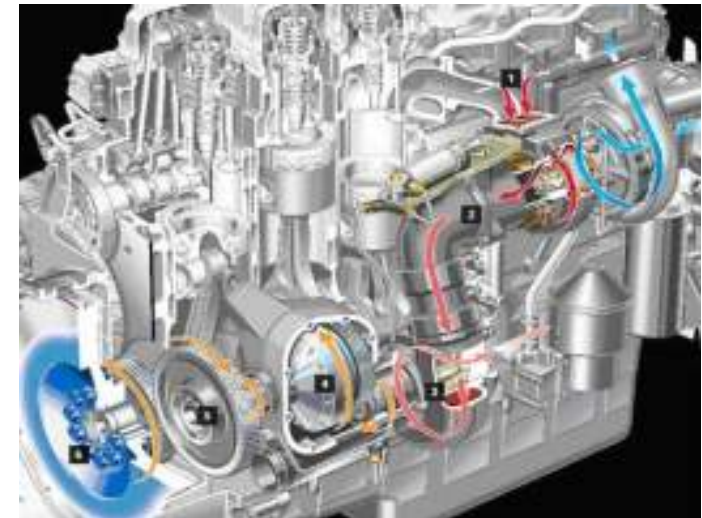

Picture: **Scania turbo compound system**
Source: www.scania.com

CO₂ Benefit

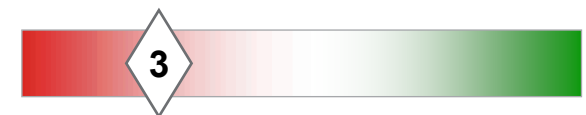

Source: Ricardo Research, Ricardo Evaluation; 1) http://www.theicct.org/documents/Greszler_Volvo_Session3.pdf Turbocompound; Presentation ICCT / Volvo Feb 2008; 2) <http://www.detroitdiesel.com/engines/dd15/specs.aspx> Detroit Diesel DD15 series; May 2009

Turbocompound technology can increase powertrain and emissions control technology (ECT) costs by up to 5 %



Technology and Environmental Cost

Technology

- Estimated adding costs on to powertrain / ECT for a mechanical turbocompound system (exhaust power turbine, gear drive, fluid coupling and gear reduction to crankshaft) are ~ 5 % (heavy duty) and up to ~ 10 % (medium duty)
- Estimated cost increase is unlikely to be acceptable for medium duty applications where the CO₂ benefit will be negligible

Estimated Cost (£)	Medium Duty	Heavy Duty
Powertrain	£2,850	£6,000
ECT	£1,0000	£1,500
TOTAL	£3,850	£7,500

Estimated cost as % of total		
Mechanical turbocompound	9.9	5.1

Environmental

- The environmental impact of turbocompound systems compared to a standard system are likely to be minor. Additional components, slightly increased manufacturing and additional materials can cause an effect in terms of CO₂ emissions due to manufacturing and resourcing
- The higher exhaust backpressure may have a beneficial impact on engine out NOx emissions at Euro 4 but as we move to increased use of emissions control technology in the exhaust line, the effect of extracting exhaust energy may be detrimental

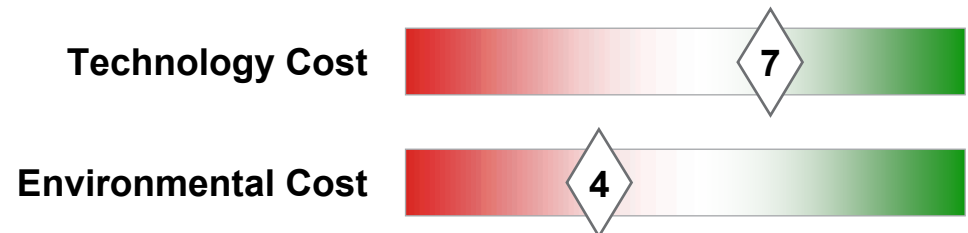

The technology has no safety and specific limitations, but can conflict to some extent with advanced EGR systems

Safety and Limitations

- ✓ System durability – in production
- ✗ Turbocompound system cools down exhaust temperature system and affects aftertreatment efficiency
- ✗ System weight and complexity
- ✗ Advanced, highly cooled EGR system reduce available exhaust energy

Technology Maturity

- In production:
 - Scania DT12 I6 12 litre Euro 4
 - Volvo D12 500TC
 - Detroit Diesel DD15 series

Safety and Limitations

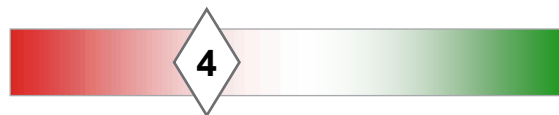

Maturity



Waste heat recovery with moderate potential for CO₂ reductions – exhaust recovery systems: Electrical Turbocompound

Waste recovery systems – electrical turbocompound

- **Concept:** Exhaust gas energy recovery
- **Base Functioning:** Exhaust turbine in combination with an electric generator / motor to recover exhaust energy
 - Recovered energy can be stored or used by other electrical devices
 - Motor during transients to accelerate
- **CO₂ Benefit:** Fuel economy benefit of 10 % achievable at maximum power point¹. Real world benefit closer to 3% depending on duty cycle. ETC perhaps best suited to off-highway applications like ploughing tractor which runs a long time at max power
- **Costs:** Increasing costs for turbocompound system

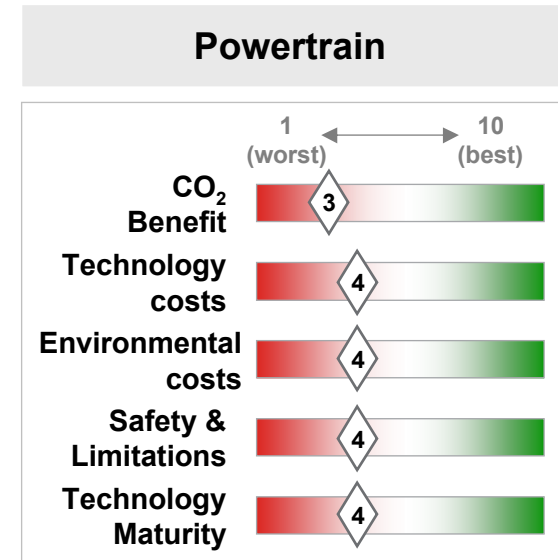

Safety and Limitations

- ✓ Moderate potential in reduction of fuel consumption and CO₂ emissions
- ✓ Primary for new engine designs
- ✗ Added complexity for energy storage, control
- ✗ Increased costs generator turbine, energy storage, crank mounted motor
- ✗ High voltage system

Technology Applicability

- Electric turbocompounding systems for medium and heavy duty application in development phase
- Fuel / CO₂ benefits confirmed

Visualisation

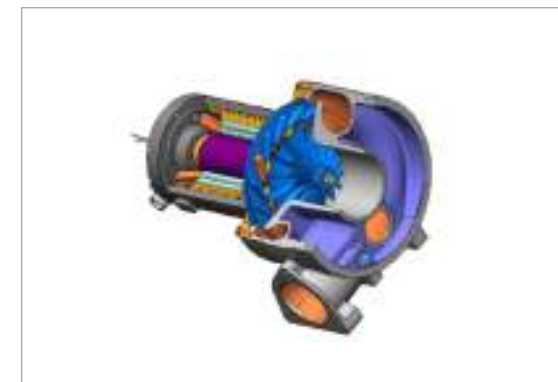

Picture: John Deere- Bowman Power turbogenerator
Source: <http://www1.eere.energy.gov> DEER 2006

Source: Ricardo Research, Ricardo Evaluation; 1) <http://www1.eere.energy.gov>; Electric turbocompounding; John Deere; DEER 2006 – Full sources available on detail slides in the attached annex

Electrical turbocompound with high CO₂ reduction potential over engine speed range



Technology Description

- As opposed to mechanical turbo compound systems Electric Turbocompound systems do not have a mechanical connection to the engine crankshaft
- These systems have a high voltage electric machine connected to the turbo shaft, which operates as a generator:
 - Generator when the power produced by the turbocharger turbine exceeds the power requirement of the compressor
 - Energy can drive a crank mounted motor to deliver additional power to the engine or energy can be stored in battery / flywheels and used for hybrid applications
- Can be used to modulate exhaust back pressure, to achieve high EGR rates – low NOx emissions for future emissions legislation
- However may have an adverse impact on the temperature of downstream emissions control technology (ECT)
- Significant level of energy generated by the generator – most practical to use a flywheel mounted motor to utilise energy as it is generated without energy storage, although in principle can be integrated into a hybrid system

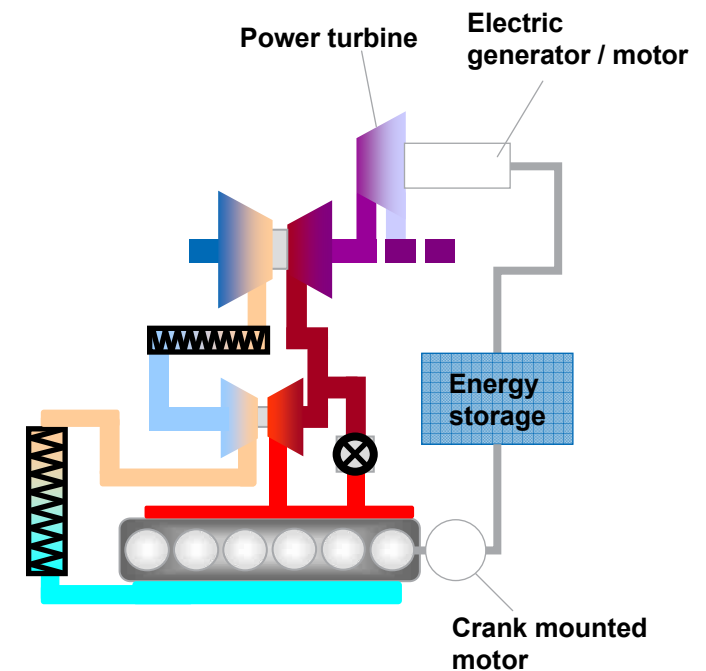

Picture: Turbogenerator – system layout

Electric turbocompound systems have benefits at all load conditions and improve CO₂ emissions up to 10%

CO₂ Benefit

Electric turbocompound

- John Deere / Bowman power turbogenerator – bufferless electric turbocompound system can achieve 10% CO₂ / fuel consumption improvement¹⁾

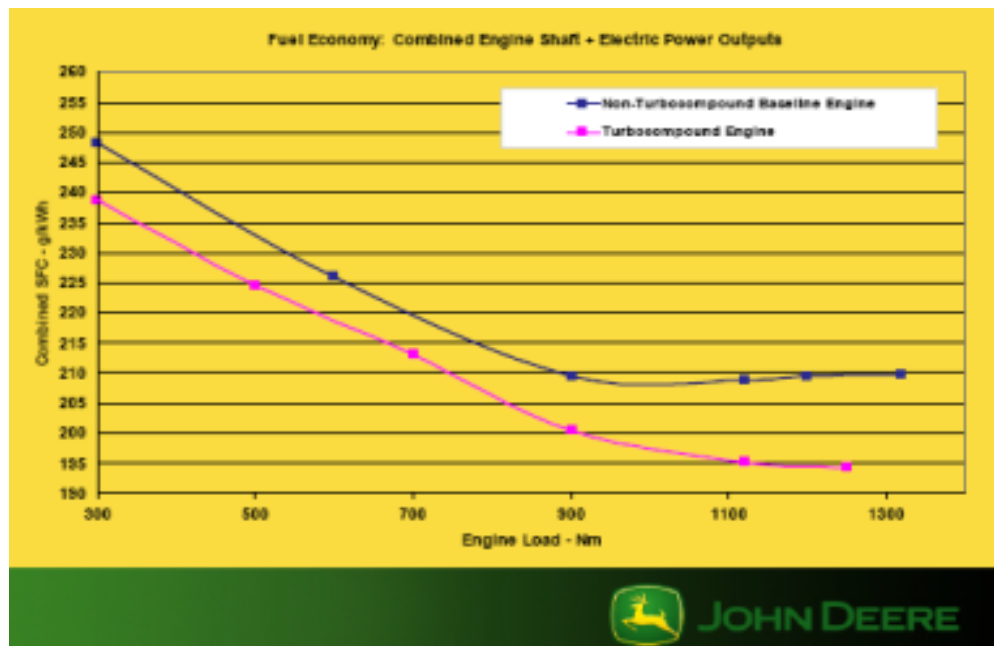

Picture: DEER 2007; Fuel consumption benefit electric turbocompound ²⁾

Electric turbocompound

- Bowman electric turbocompound systems can reduce CO₂ / fuel consumption by ~ 7 % according to their website²⁾
- The reality is that the achievable CO₂ benefit is strongly dependent on the duty cycle. For a typical truck on cross-country/highway mixed cycle, average engine power is ~25% of maximum engine power, and so achievable CO₂ benefit from electrical turbocompound might be proportionally lower – say 2-2.5%

CO₂ Benefit

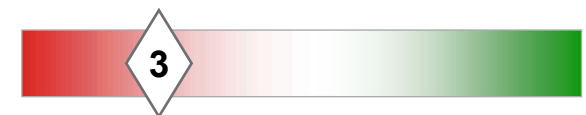



Electric turbocompound systems have a medium to high CO₂ reduction potential at significant cost increase of up to ~ 40 %

Technology and Environmental Cost

Technology

- Adding costs on electric turbocompound systems for medium and heavy duty trucks are estimated to be in a 22 % to 42 % range (increasing powertrain and emissions control technology (ECT) costs)
- Technology includes power turbine, turbine generator/motor, crank mounted motor and/or energy storage device

Estimated Cost (£)	Medium Duty	Heavy Duty
Powertrain	£2,850	£6,000
ECT	£1,0000	£1,500
TOTAL	£3,850	£7,500

Estimated cost as % of total		
Electric turbocompound	42.4	21.8

Environmental

- The environmental impact of electric turbocompound systems compared to a standard system are based on additional components, increased manufacturing and additional materials. It can impact the overall technology CO₂ emissions due to manufacturing and resourcing.
- Emissions reduction through power and efficiency increase may be offset by adverse impact on exhaust aftertreatment

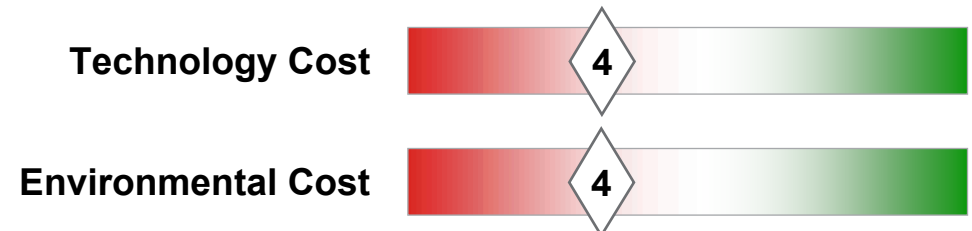

Electric turbocompound systems have moderate CO₂ reduction potential and “are on the brink of commercialisation”

Safety and Limitations

- ✓ Technology for wide engine speed / load range
- ✓ Combination with other hybrid technologies possible
- ✗ High voltage systems
- ✗ Vehicle system package
 - System weight and complexity
- ✗ Exhaust energy stream has conflicting constraints:
 - Advanced, highly cooled EGR system reduce exhaust energy
 - Turbocompound system cools down exhaust temperature and affects aftertreatment efficiency

Technology Maturity

- John Deere and Bowman demonstrated system capability
- Major OEMs are interested in electric turbocompound / turbogenerator technology
- Challenge is reducing system costs to cut down technology pay-back time

Safety and Limitations

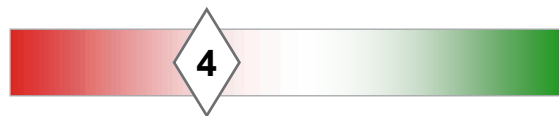

Maturity

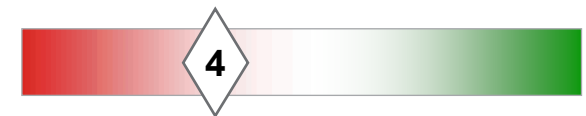

Waste heat recovery with high potential for CO₂ reductions – exhaust recovery systems: heat exchanger

Waste recovery systems – heat exchanger

- **Concept:** Exhaust gas energy recovery with heat exchangers. Sometimes called “bottoming cycles” (power station terminology, as it takes out low grade heat from the “bottom” of the thermodynamic cycle)
- **Base Functioning:** Exhaust gas heat used in exchanger to drive an additional power turbine to generate energy
 - Brayton cycle
 - Rankine cycle
- **CO₂ Benefit:** 3-6% CO₂/ fuel economy benefit depending on cycle and turbine efficiency
- **Costs:** Depending on technology,

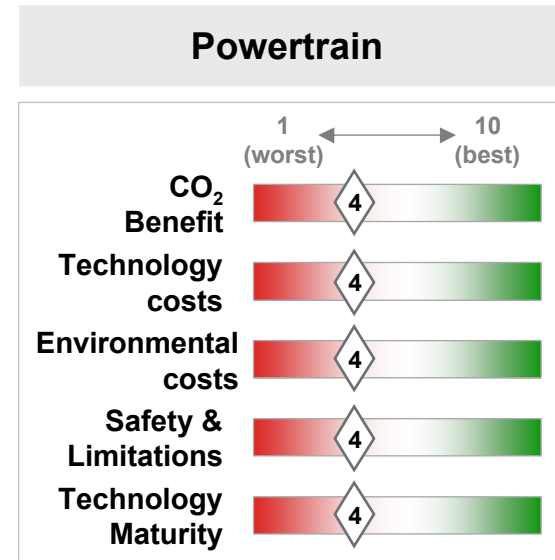

Safety and Limitations

- ✓ High potential in reduction of fuel consumption and CO₂ emissions
- ✓ Depending on cycle (exchanger) and turbine efficiency
- ✗ Additional working fluid (Rankine cycle)
- ✗ Added complexity for energy storage, control, packing
- ✗ Increased costs heat exchanger, high efficiency turbine,
- ✗ High voltage system

Technology Applicability

- Research phase
- Intruction in heavy duty application might be easier due to packaging

Visualisation



Picture: Caterpillar package layout – Brayton system¹⁾

Source: Ricardo Research, Ricardo Evaluation; 1) <http://www1.eere.energy.gov>; Kruiwyk; Exhaust waste heat recovery, Caterpillar; DEER 2008 -- Full sources available on detail slides in the attached annex

Exhaust energy recovery systems using Rankine and Brayton cycle offer high CO₂ reduction potential



Technology Description

- Thermodynamic heat energy recovery with different principles
 - Brayton and Rankine cycle most interesting for automotive applications
- Brayton cycle – gas turbine cycle
 - Heat exchanger (HE) in EGR circuit extracts exhaust energy in form of heat. The HE replaces the EGR cooler which would normally be present, rejecting heat to the engine coolant
 - Additional compressor sucks in atmospheric air, which is heated in the HE and expands, giving up its power to the turbine
 - The turbine drives the generator and produces energy, which can provide additional power to the crankshaft or can be stored in battery / flywheel hybrid system
 - No additional fluids – air as working gas
 - Does not impact the engine air/EGR system pressures or temperatures when packaged in place of EGR cooler
 - Lower cost compared to Rankine cycle
 - Packaging relatively simple compared to current engine layout
 - Lower overall cycle efficiency compared to Rankine cycle

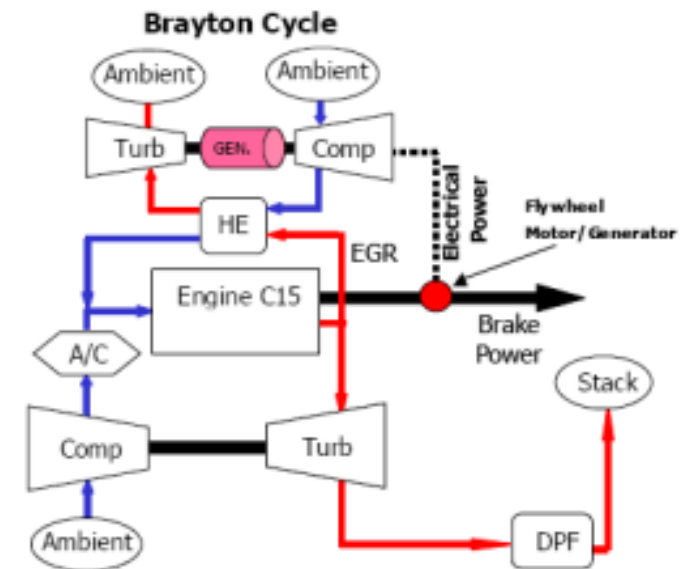

Picture: Caterpillar layout for HECC HPL EGR waste heat recovery system – Brayton¹⁾

Exhaust energy recovery system using Rankine and Brayton cycle offer high CO₂ reduction potential



Technology Description

- Rankine cycle – thermodynamic cycle with phase change
 - Additional working organic fluid (water, ammonia, butane)
 - 2 heat exchangers extracting exhaust energy to evaporate fluid into gas/steam (EV), superheat the vapour to higher temperature (SH)
 - A recuperator (RC) and condenser reverse the phase change (condense the vapour back to liquid for pumping)
 - Hot gas/steam powers turbine and a pump to drive working fluid around the system
 - Generator produces energy to use directly on the crankshaft or for hybrid systems
 - Fluid as working medium – may need to be organic (i.e. hydrocarbon based) with phase change ~200°C (phase change improves cycle efficiency)
 - Insensitive to back-pressure as high pressure EGR system layout
 - High costs and system packaging compared to Brayton
- Challenges for bottoming cycles
 - Cycle and turbine efficiency
 - Packaging requires very compact and efficient heaters
 - Transmission of electrical machines
 - Conflict with aftertreatment temperature requirements unless packaged in EGR circuit, where only low grade heat is available

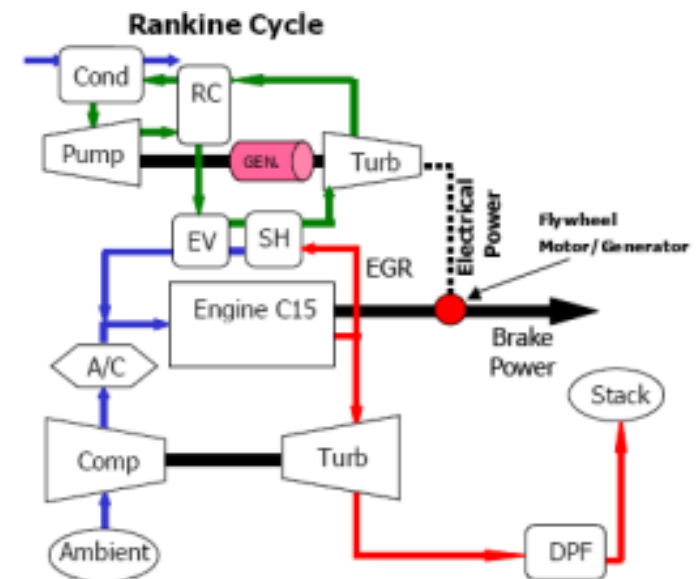

Picture: Caterpillar layout for HECC HPL EGR waste heat recovery system – Rankine

Simulations show an CO₂ emissions improvement of up to 6% with Thermodynamic cycles for waste heat recovery

CO₂ Benefit

Brayton cycle – simulation results

- System capable of 1.5-4% CO₂ reduction, depending on turbomachinery efficiency
 - Assumptions:
 - Turbo efficiency 70%
 - Heat exchanger efficiency 80-90%
 - Transmission efficiency 90%

Rankine cycle – simulation results

- Expected CO₂ reduction potential 3-6% depending on EGR rate
 - Assumptions:
 - Turbine efficiency 70%
 - Multiple heat exchangers
 - Transmission efficiency 90%
 - Pump efficiency 45-65%
 - Working fluid R245fa
- Gasoline “Turbosteamer” BMW claims 10-15% CO₂ reduction with a exhaust heat transformer working with Clausius-Rankine cycle¹⁾
 - System tested on test bed conditions
 - Expected 80% heat recovery from coolant and high grade exhaust heat

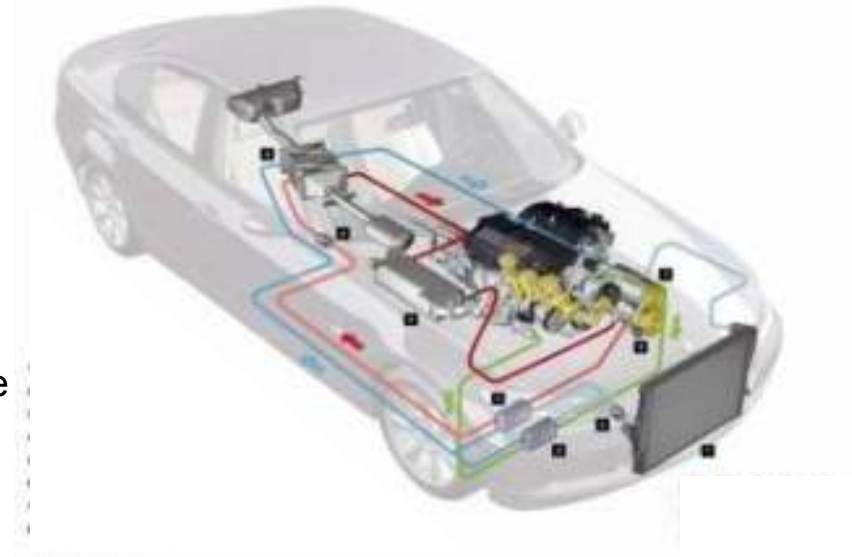

Picture: Turbosteamer in vehicle BMW 3-series; layout concept¹⁾

CO₂ Benefit

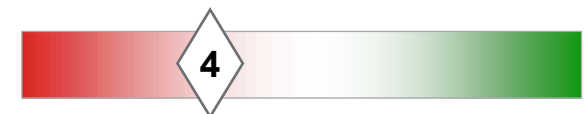

Source: Ricardo Research, Ricardo Evaluation; <http://www1.eere.energy.gov>; Kruiiswyk; Exhaust waste heat recovery, Caterpillar; DEER 2008; 1) The turbosteamer - a system introducing the principle of cogeneration in automotive applications MTZ Worldwide, May 2008, pp20-27



Thermodynamic processes for waste heat recovery will have a significant impact on Technology cost by up to 70 %

Technology and Environmental Cost

Technology

- Waste heat recovery systems using Brayton and Rankine cycle will increase costs by a significant proportion of the total powertrain and ECT costs
- All systems are still in a research stadium and cost assumptions are very difficult
- Table shows an initial estimate for an waste heat recovery system using the Rankine cycle and highlights the significant impact on powertrain and ECT cost. NB. The cost estimate does not include any hybrid system necessary to utilise the electric power

Estimated Cost (£)	Medium Duty	Heavy Duty
Powertrain	£2,850	£6,000
ECT	£1,0000	£1,500
TOTAL	£3,850	£7,500

Estimated cost as % of total		
Waste Heat recovery using Rankine	70.6	36.3

Environmental

- Additional organic working fluids, which can add CO₂ emissions for production and transport. Also, special maintenance work might be necessary and service personal training might be required.
- Vehicle weight increase can increase emissions and fuel consumption in general.
- System production and materials adds costs and possibly CO₂ emissions.

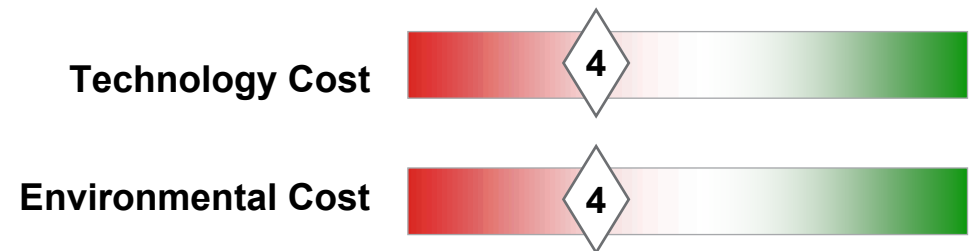

Waste heat recovery systems are still in a research phase and safety and limitation issues under investigation

Safety and Limitations

- ✓ Combination with hybrid technology
- ⊖ Safety issues with organic working fluids, crash protection e.g. for condenser
- ⊖ Limited performance benefit using low grade heat, to access higher grade heat puts system into competition with exhaust gas aftertreatment
- ⊖ Additional system maintenance, like fluid change intervals
- ⊖ Packaging limitations and increase powertrain weight
- ⊖ Expected cost increase

Technology Maturity

- Waste exhaust energy recovery with thermodynamic processes is still in a research and development status
- OEMs are very interested in these technologies and publications are numerous, e.g. Cummins, Caterpillar and BMW

**Safety and
Limitations**

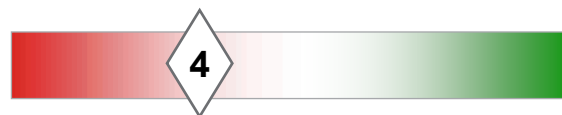

Maturity

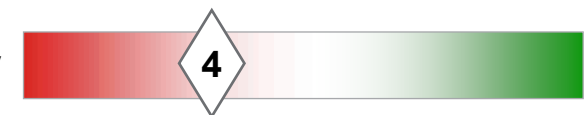

Waste heat recovery with potential for CO₂ reductions – exhaust recovery systems: thermo-electric processes

Waste recovery systems – thermoelectric generators

- **Concept:** Exhaust gas energy recovery with thermoelectric heat exchangers
- **Base Functioning:** Thermoelectric generators using Seebeck effect, creating a voltage at the present of a temperature difference in between two different metals or semiconductors. Direct conversion of heat to electricity. Nearly 25% of fuel energy is typically lost to the exhaust stream. Typically implemented using extremely advanced materials: SiGe quantum dots/wells, nanomaterials, PbTe wafers, filled Skutterudites (CoAs₃ based crystal lattices), Mischmetal (cheap naturally occurring CeLa alloy)
- **CO₂ Benefit:** ~2 % CO₂ / fuel economy benefit
- **Costs:** Significant at current research level

Safety and Limitations

- ✓ Medium potential in reduction of fuel consumption and CO₂ emissions
- ✗ Technology depending on development of materials with high merit figure in a realisable manufacturing process
- ✗ High costs for materials and processing
- ✗ Low TE module conversion efficiencies with actual bulk materials

Technology Applicability

- Research phase

Powertrain

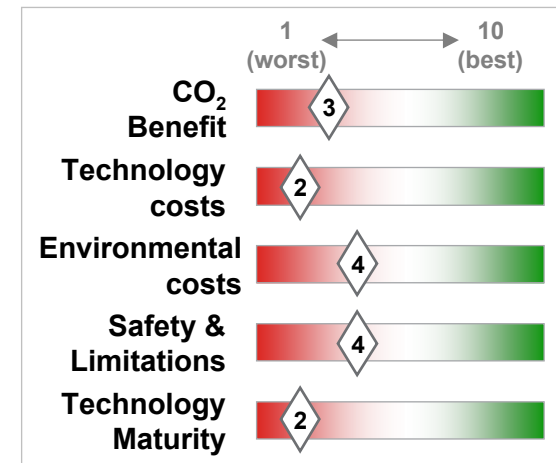

Visualisation

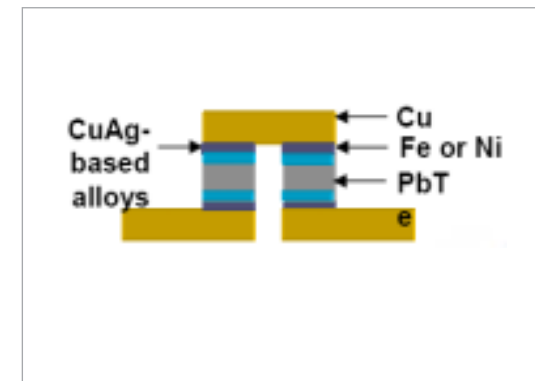

Picture: Layout thermoelectric generator, Ed Gundlach GM DEER 2008

Exhaust energy recovery system as thermo electrical generators with high theoretical CO₂ reduction potential

Technology Description

- Thermo-electric processes, which are under investigation by different research facilities and companies:
 - Seebeck effect
 - Lithium-hydride electrochemical cell
 - Thermo-photo-voltaic (thermal emitter + PV)
 - Thermo-tunnelling / thermo-ionic emission
- One selected CO₂ reduction technology are thermoelectric generators using the Seebeck effect (conversion of temperature difference to electric voltage – the same principle used for thermocouples)
 - Thermoelectric generators can utilise from any high temperature source. For engines this may be, for example, from the exhaust gas, or from the EGR cooler (where fitted)
- A number of issues to be addressed before a practical solution is identified, including:
 - Heat exchange: to make best use of the hot and cold temperature sources
 - Heat transfer in the thermoelectric couple
 - Durability: thermal stresses, de-lamination
 - Management of the electrical energy (storage and utilisation) must be considered

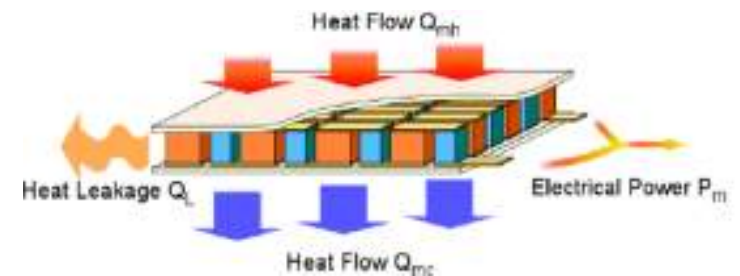
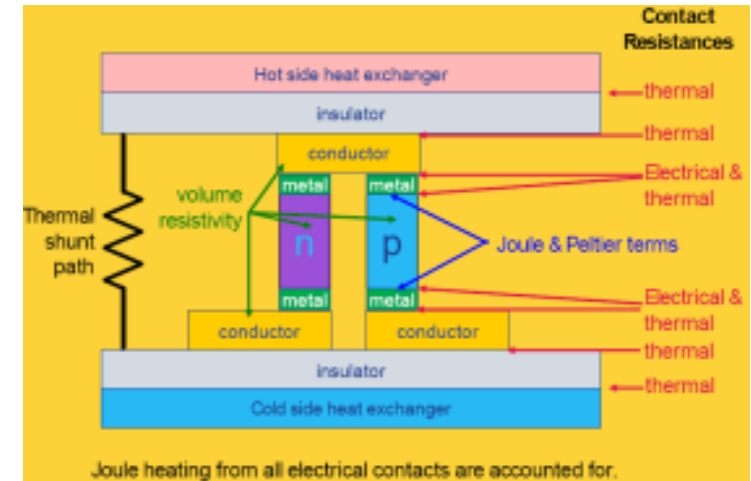

Pictures: Design/Function Thermoelectric generator, Jihui Yang GM DEER 2006

Simulations predicting up to 2% reduction in CO₂ emissions with actual thermoelectric elements

CO₂ Benefit

Simulation – thermoelectric generator

- Average/max output ~ 350 W/914 W over urban cycle
- Potential CO₂ improvement over a passenger car Urban/Highway cycle expected to be ~3-4%¹⁾ assuming TE device replaces conventional alternator and that battery or accessories can absorb the load
 - Based on PbTe thermoelectric element
 - Thermoelectric efficiency not published but mean exhaust stream power = 14kW so estimate 2.5%
 - Published sources for PbTe material quoting efficiencies < 1%²⁾, highlights uncertainty in simulation and/or quoted efficiency values
- A typical truck alternator is 2kW and average truck power is 95kW in real world driving, so scaling this approach would result in theoretical maximum CO₂ improvement of 2%
 - Assuming battery/accessories absorb load
 - Assuming cost effective scalability

Picture: Design thermoelectric generator In exhaust, Ed Gundlach GM DEER 2008

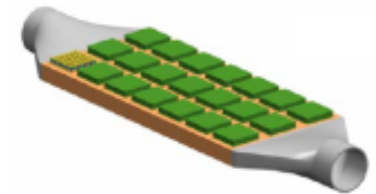

Power vs. Time - Urban drive cycle

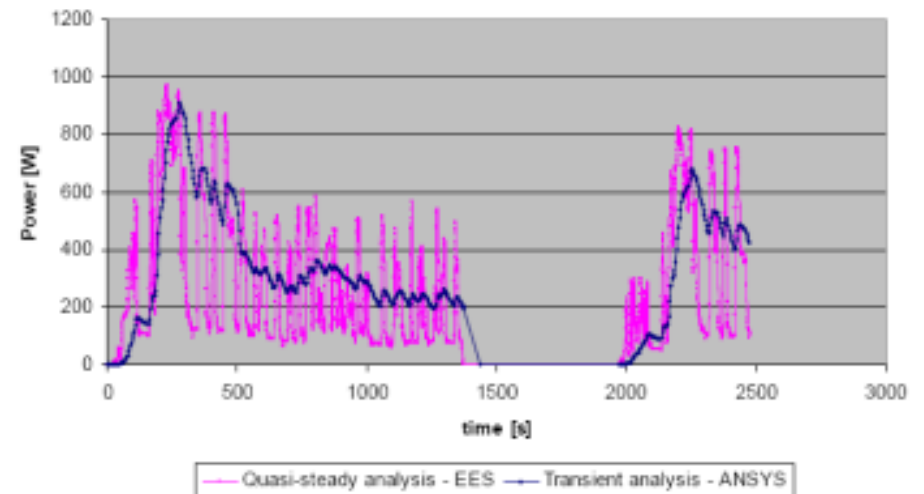

Picture: Power output SIMULATION thermoelectric generator, Ed Gundlach GM DEER 2008

CO₂ Benefit



Source: Ricardo research, ricardo analysis; http://www1.eere.energy.gov/vehiclesandfuels/pdfs/deer_2006/session6/2006_deer_yang.pdf; Thermoelectric generator; GM; DEER 2008; 1) http://www1.eere.energy.gov/vehiclesandfuels/pdfs/deer_2008/session7/deer08_gundlach.pdf; Thermoelectric technology; GM; Gundlach DEER 2008; 2) http://www1.eere.energy.gov/vehiclesandfuels/pdfs/deer_2008/poster3/deer08_bass.pdf; Thermoelectric materials; Hi-Z; DEER 2008

Thermodynamic processes for waste heat recovery will have a relatively significant impact on Technology cost

Technology and Environmental Cost

Technology

- High material and process costs. As a typical example, the quantum well materials (materials which constrain particle movement to 2 dimensions) under research are made using nano-manipulation techniques e.g. using a scanning electron microscope or scanning tunnelling microscope, or via sophisticated vapour deposition techniques. Conversion of these techniques to a practical production process is a significant challenge

Environmental

- Production processes may be energy or raw materials intensive on an industrial scale
- Exotic materials for high efficient TE modules
- Life time/range of TE modules and recycling
- Risks as yet unquantified, processes not yet developed

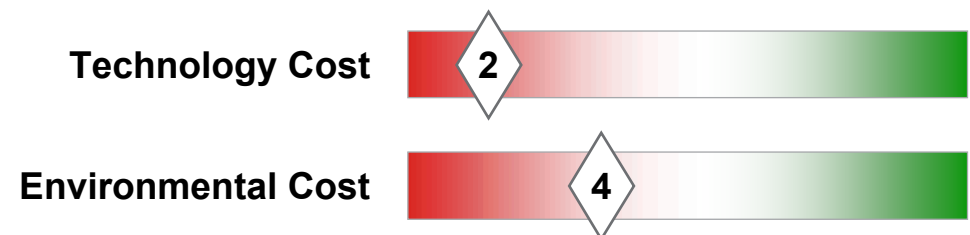

The technology has no safety limitations, but is relatively immature

Safety and Limitations

- ✓ Readily integrated into existing engines - after-treatment temperature matching needs considering
- ✓ Much lower backpressure impact than turbo-compound
- ✗ Material cost/performance major issue

Technology Maturity

- Thermoelectric generators are in an early research phase
- Thermoelectric process is understood and development targets are set to improve device efficiency and develop industrial processes
- Technology steps – Research – Development – System integration – Introduction in production

Safety and Limitations

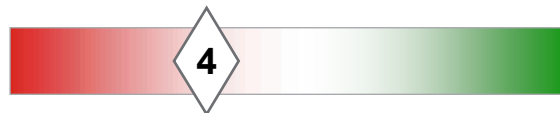

Maturity



- **Feasibility Analysis**
 - Vehicle Technologies
 - **Powertrain Technologies**
 - Engine Efficiency
 - Waste Heat Recovery
 - **Alternative Powertrains**
 - Transmissions
 - Fuel Technologies

Fuel Cell systems have the potential to power vehicles, such as buses, with zero tailpipe emissions

Fuel Cell Powertrains

- Concept:** Fuel cells are often viewed as the powertrain of the future. Fuel cells convert the chemical energy of hydrogen into electrical energy that can be used to power the vehicle.
- Base Functioning:** A hybrid Polymer Electrolyte Membrane (PEM) fuel cell system is used as the prime mover for the vehicle
- CO₂ Benefit:** PEM FC systems run on hydrogen produce zero tailpipe emissions, however the WTW CO₂ benefit depends on how the H₂ was produced
- Costs:** Although costs are reducing, a FC bus still costs 3-6 times more than the price for a conventional bus

Safety and Limitations

- Hydrogen fuel cell powered buses have been safely demonstrated in several cities throughout the world
- The lack of hydrogen infrastructure limits current use to fleets that regularly return to a depot
- Staff training would be required to ensure safe handling of the hydrogen fuel and fuel cell system

Technology Applicability

- Fuel cell technology has successfully been demonstrated in city buses
- At least one European developer plans to market a fuel cell hybrid 7.5 tonne truck, however since production volumes will initially be low, this will be a niche product

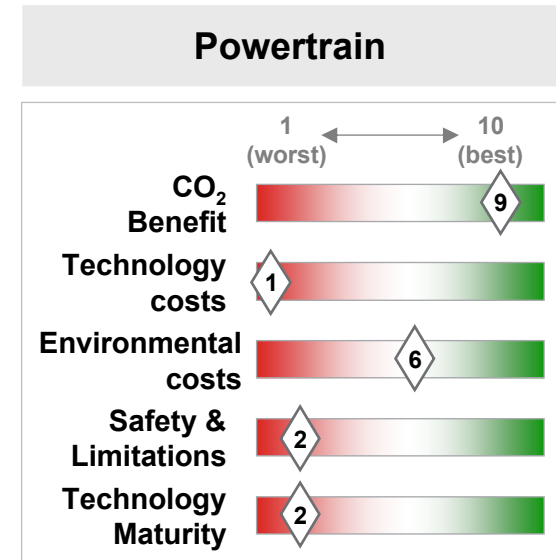

Visualisation



Picture: Transport for London, Hydrogen Bus

Fuel cell powered buses have been successfully trialled in over 20 cities throughout the world



Technology Description

Fuel Cell Systems

- A fuel cell is a device that converts the chemical energy of hydrogen into electricity, with water and heat as by-products (i.e. zero tailpipe emissions)
- In addition to the PEM FC stack, a fuel cell powertrain system also requires balance of plant components, heat exchangers and cooling equipment, power converters and electric motors
- Since the mid-1990s there have been numerous fuel cell bus projects in operation throughout the world. These buses have tended to use Polymer Electrolyte Membrane (PEM) fuel cell technology to power the bus. More recent prototypes include batteries or super capacitors to make a hybrid system.
 - The PEM FC systems tend to be ~20kW to power a hybrid mini bus and 120-180kW to power a city bus
- A Dutch partnership (Boudestein, e-Traction and NedStack) have created the Hytruck, a 7.5 tonne truck powered by a fuel cell plug-in hybrid system. The Hytruck C8HE is based upon a conventional chassis of the Mitsubishi Canter 7.5ton distribution vehicle, with a completely new concept drive line, the Hytruck H2E driveline.
 - PEM fuel cells are mounted under the cab producing 16 kW
 - Up to 5.8kg of hydrogen is stored at 350 bar in the 227 litre carbon composite type 4 gas tank
 - The plug-in hybrid system includes Lithium-ion Phosphate batteries
 - The vehicle weight is 3800 kg and maximum payload 3700 kg
 - Maximum speed is 85 km/h and the driving range is 450 km
 - Hytruck claim their Well-to-Wheel efficiency to be 34%



Picture: Icelandic New Energy



Picture: Ballard



Pictures: HyTruck

A few fuel cell powered trucks and vans are currently being developed

Fuel Cell Systems (continued)

- Daimler are developing a prototype fuel cell hybrid delivery van as part of the EU FP6 HySYS project
 - This vehicle will be the Full Power Fuel Cell Validator for the project, which is aiming to improve the system components for a fuel cell hybrid vehicle
 - This 3.5 tonne vehicle will be powered by a 70-90 kW fuel cell with 30-50 kW Li-ion battery pack. Its driving range will be > 300 km. The weight of the empty vehicle will be 2.7 tonnes.
- Vision Motor Corp. in USA have developed the Tyrano, a plug-in electric/hydrogen fuel cell powered heavy duty class 8 truck
 - Carries 33kg Hydrogen
 - Range is > 550 km



Picture: HySYS Project



Picture: Vision Motor Corp – Vision Tyrano prototype

Hydrogen On-board Storage

- PEM FC systems require very pure hydrogen for the fuel, which must be storage on-board the vehicle
- For the HyFLEET:CUTE project, Mercedes Benz provided PEM FC buses which each had 9 pressure cylinders for storing hydrogen at 350 bar, and were capable of a driving range of approximately 200 km, with a maximum speed of 80 km/h
- The Hytruck has a 227 litre carbon composite type 4 gas tank with polymer liner which can contain 5.8 kg of hydrogen at a pressure of 350 bar
- Further information on hydrogen storage is provided in the Hydrogen Section of this report

PEM FC powertrains run on H₂ produce zero tailpipe emissions, however WTW CO₂ depends on how the H₂ was produced



CO₂ Benefit

- Fuel cell systems which run on pure hydrogen, such as PEM, only produce water and heat as by-products. Therefore, this is a zero emission technology at point-of-use
- However, the WTW analysis depends on the energy source and production method used to produce the hydrogen (see Hydrogen Section of this report for further information)



The “Window of Opportunity” for FC-powered buses shows it is difficult to make a business case for this technology on costs alone



Technology and Environmental Cost

Technology

- For information on the cost of hydrogen, see the Hydrogen Section of this report
- The current cost of a hydrogen fuel cell bus is currently 3-6 times the cost of a conventional bus
- The Roads2HyCom project accessed the “windows of opportunity” for future fuel cell buses in terms of FC system and hydrogen costs, based on comparison with conventional diesel and diesel-hybrid buses
 - The results show that it is difficult to make a business case for FC buses based on costs alone
- Hytruck intend to launch their fuel cell plug-in hybrid truck in late 2009. Initially this vehicle is cost €500,000 since volumes will be low (<10) and the trucks will be built by hand. Hytruck hope to reduce their price to €150,000-€200,000 within a couple of years

Environmental

- Fuel cells contain precious metals, such as platinum, which are energy intensive to produce
- When in use, the only emission from a PEM FC system is water
- Since they have fewer moving parts, fuel cell systems are much quieter to operate than ICEs

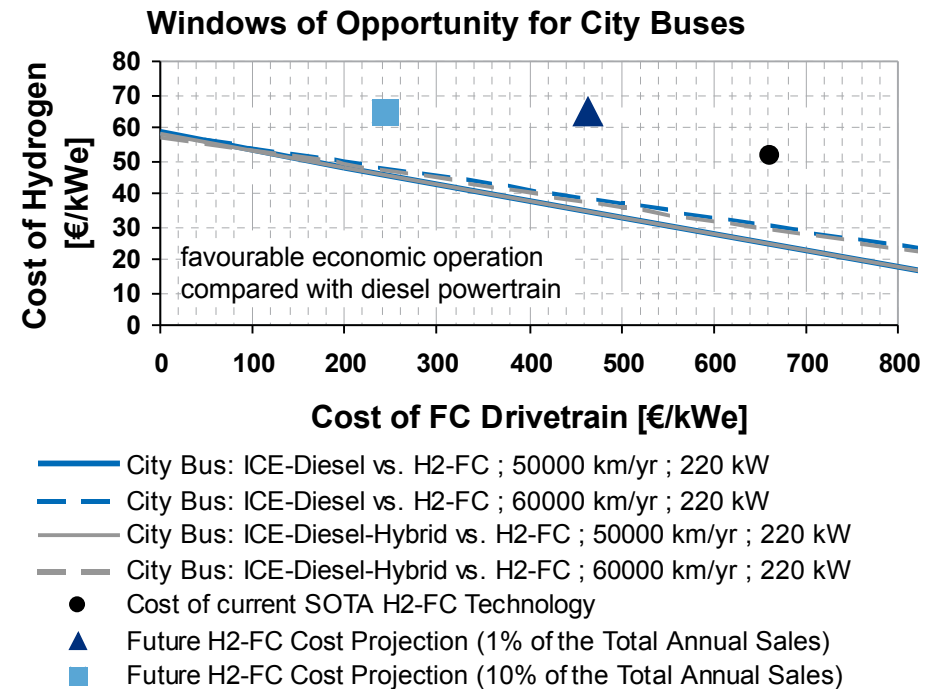

Picture: Roads2HyCom (ECN)

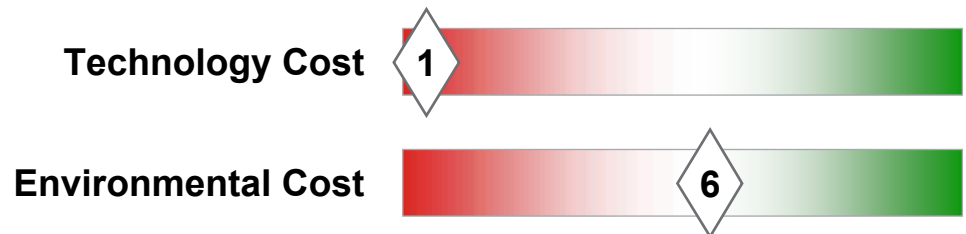

Lack of hydrogen infrastructure and technology maturity suggest fuel cell powertrains will be a niche product in the HGV sector

Safety and Limitations

- ✓ Hydrogen fuel cell powered buses have been safely demonstrated in several cities throughout the world
- ✗ The lack of hydrogen infrastructure limits current use to fleets that regularly return to a depot
- ✗ Staff training would be required to ensure safe handling of the hydrogen fuel and fuel cell system
- ✗ Since the overall weight on the fuel cell system, including hydrogen storage tanks and batteries, is heavier than the conventional diesel powertrain, the payload is compromised

Technology Maturity

- To date, over 100 fuel cell city buses have been demonstrated in real world conditions
- The makers of the fuel cell plug-in hybrid Hytruck plan to launch the vehicle at the end of 2009. However this is a niche product and volumes are expected to be low (initially < 50 units per year)

Safety and Limitations



Maturity

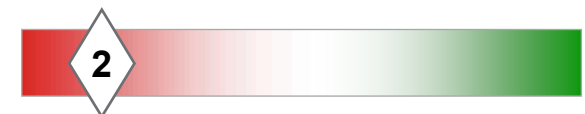



Another application for fuel cell technology on heavy-duty trucks is auxiliary power units for managing hotel loads

Fuel Cell APUs

- Concept:** Fuel cell auxiliary power unit (APU) to supply electricity for hotel loads in long-haul heavy duty trucks while stationary, instead of idling the main engine
- Base Functioning:** The FC APU system provides electricity for the on-board hotel loads such as cabin heating and cooling, computer, GPS equipment, and electrical appliances
- CO₂ Benefit:** It is expected that this technology will offer a CO₂ benefit due to reduced fuel consumption, but since the technology is still under development the actual CO₂ benefit has not yet been published
- Costs:** Once ready for market, it is expected that FC APU systems will have a payback period of < 2 years in terms of fuel saved

Safety and Limitations

-  Fuel reformers are currently being developed so that fuel cell APUs can be run on conventional fuels such as diesel or biodiesel
-  A new technology will require an appropriate certification process to prove it is safe to use
-  Currently, fuel cell APU products for trucks are being developed for the North American market, not the European market

Technology Applicability

- Fuel cell APUs offer an alternative to idling the main engine when the vehicle is stationary. This would lead to significant fuel savings and corresponding reduction in tailpipe emissions
- This technology is particularly applicable to long-haul trucks which require electricity to run hotel type loads while stationary

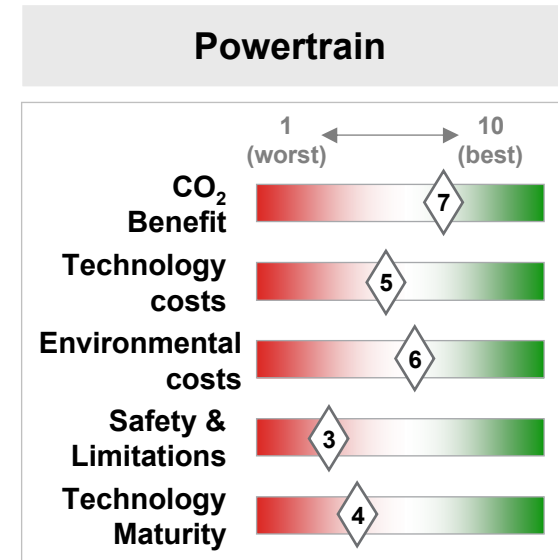

Visualisation



Picture: Ricardo

Several consortia are developing fuel cell APU products for the North American long-haul truck market



Technology Description

- Several consortia are currently developing fuel cell APU systems for large truck applications. The main players include Delphi and Cummins in the USA, and PowerCell in Europe. The target market area is North America. The development is being driven by the increasing demand for hotel loads in truck cabins (heating, cooling, and powering electrical equipment such as fridges, laptops and GPS systems) and anti-idling legislation in some states preventing truck drivers leaving the engine to idle while stationary.
- SOFC and PEM FC technology are both being considered in fuel cell APU development for trucks.
- Fuel Cell APUs can be designed to run on a range of fuels, such as Diesel, Methanol, LPG, and JP-8
- Many fuel cell APUs contain a built in fuel reformer. Reformer technologies under development include:
 - CPOx
 - Recycle Based (Endothermic)
 - Autothermal
- Many fuel cell APU system under development either include batteries within the unit, or work in tandem with the batteries in the vehicle, to create a hybrid system



Picture: Ricardo, model of TMI FC APU system developed in collaboration with Ricardo



Fuel cell APUs would provide an alternative to engine idling, thus contributing to fuel savings and emissions reduction

CO₂ Benefit

- In 2005 the American Transportation Research Instituted carried out a survey on fleet preferences for idle reduction technology. They found that, on average, sleeper cabs idle the engine 28 hours per week (1,456 hours per year), while day cabs idle the engine 6 hours per week (312 hours per year). The average cost of idling was estimated to be \$3.00/hr.
- Running a SOFC APU 3-5kW system on diesel will produce CO₂ emissions. However this will be significantly less than running the main engine at idle, leading to a CO₂ benefit.

Technology and Environmental Cost

Technology

- Since FC APU systems are still at the prototype stage of development it is difficult to obtain data on their likely price at point of market entry. However the competing technology of a gen set APU currently retails at \$7000-\$8000 in USA.
- FC APU developers are aiming for a payback period of < 2 years

Environmental

- Running a 3-5 kW SOFC APU system with a fuel reformer will produce significantly less emissions than idling the main truck engine
- The fuel cells and battery in the FC APU system contain precious metals, such as platinum, which are energy intensive to produce

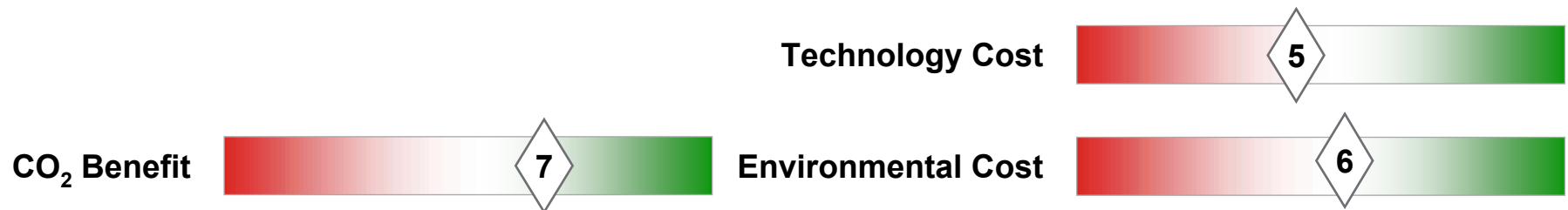

The development of fuel cell APUs for trucks is still at the prototype stage

Safety and Limitations

- ✓ Fuel cell APUs will be designed to run on conventional fuels such as diesel, which means they will not require the development of a new fuel infrastructure
- ✗ Since fuel cell APU systems for trucks are a new technology product, a certification process will need to be developed to prove the product is safe to use
- ✗ The fuel cell APUs currently under development are designed for the North American long-haul truck market. Since the UK HGV market has different requirements, the technology may not directly transfer

Technology Maturity

- All fuel cell APU systems for trucks are at a prototype stage of development and have not yet been tested on heavy-duty trucks in real world conditions

Safety and Limitations



Maturity



Electric commercial vehicles are available with a GVW up to 12t and benefit from lower running costs and taxes

Electric Vehicles

- **Concept:** Vehicle which is driven by a battery powered electric motor
- **Base Functioning:** Vehicle is driven by an electric motor powered by batteries which are charged from mains electricity. The vehicle has no other power source other than the battery
- **CO₂ Benefit:** Tailpipe CO₂ emissions are 0g/km and overall emissions are estimated to be 40% lower than conventional diesel, but this is dependent on fuel source used to generate electricity
- **Costs:** Smiths Newton electric 7.5t vehicle (very similar to medium duty benchmark) is between £78,387 and £80,886
- **Environmental Benefit:** Electric vehicles have societal benefits in that they reduce road noise

Safety and Limitations

- ✓ Less stressful driving
- ✓ Lower maintenance and servicing requirements
- ✗ Lower vehicle payload than comparable diesel vehicle
- ✗ Limited to GVW of 12t
- ✗ Low residual vehicle values
- ✗ Operation limited to central depot based fleets
- ✗ Reduction in road noise needs to be handled carefully to ensure no adverse effects for vulnerable road users

Technology Applicability

- Limited to vehicles up to 12t
- Best suited to vehicles operating from a single depot and with daily mileage of <100miles
- Greatest benefit for urban applications where exemption from congestion charge and low emission and noise operation is beneficial

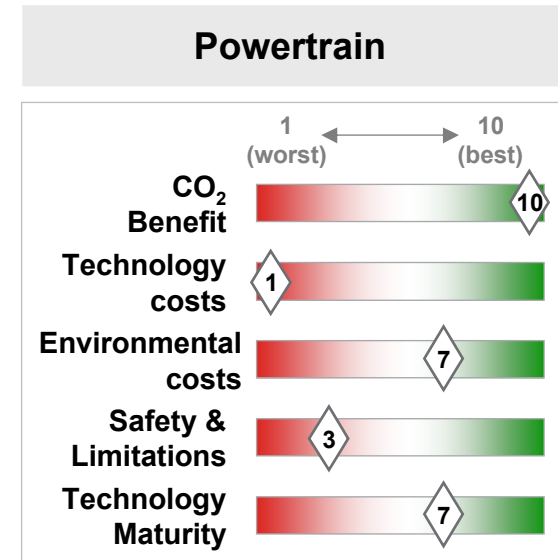

Visualisation



Picture: Smith Newton from sev-us.com

Electric vehicles are driven by battery powered electric motors, which are recharged from mains electricity



Technology Description

- Electric vehicles use an onboard battery supply to power an electric motor for propulsion. Unlike diesel and hybrid vehicles, they rely entirely on mains electricity to charge batteries to power the motor.
- Vehicles can be charged either through domestic supplies or for faster charging via a 3-phase supply. On board battery energy is conserved through the use of regenerative braking, and manufacturer's claim that vehicles have on average a range of over 100 miles, however this may be less under real world operating conditions
- Due to the high torque of an electric motor, electric delivery vehicles accelerate faster than diesel vehicles, even at maximum weight. This, combined with no need for gear changes, ensures that operation in the urban environment is comparable and at times even better than diesel equivalents
- Vehicles are currently limited to a GVW of 12t



Charging an electric vehicle

Not only are tailpipe CO₂ emissions zero, but so too are other toxic emissions along with a reduction in noise pollution

CO₂ Benefit

- 100% reduction in tailpipe CO₂ emissions
- CO₂ emissions however will still be created from electricity generation process, so fuel well to wheels CO₂ emissions still exist and are dependent on the type of electricity generation

Environmental Cost

- Not only a reduction in tailpipe CO₂ emissions but also no other toxic emissions such as NO_x and Particulates that adversely affect air quality
- Reduction in noise pollution with vehicles operating near silently, whilst this may be a benefit for early morning vehicle operations, this may also be of hazard in areas with high numbers of pedestrians who will not hear an oncoming vehicle
- Greater environmental impact of manufacture and recycling of vehicle batteries which contain toxic materials, however vehicles such as Modec vans are claimed 98% recyclable
- Lifecycle cost of battery is very uncertain and for electric vehicles is assumed to be manufactured using western technologies with limited impact on the environment



Electric vehicles are more expensive than their diesel counterparts, the majority of this cost attributed to battery and motor technology

Technology Cost

- Electric vehicles in the UK are exempt from a number of taxes and standard vehicle legislative requirements:
 - Zero Vehicle Excise Duty (VED)
 - No requirement for yearly MOT, Tachograph or Operating Licence for 7.5t GVW
 - Exemption from the London congestion charge – approximately £1,750 a year
- The cost of batteries for electric vehicles are currently above \$1,000/kWh
- Battery life likely to be 3-5 years, so will have to be replaced at least once during vehicle life
- Higher purchase / leasing cost than a diesel vehicle, over double that of a conventional vehicle
- More suited to urban delivery where return to base recharging possible due to very high cost of proving wide charging infrastructure
- Fuel cost approximately 20% of diesel equivalent, on average £40-a-week to as opposed to around £200
- **Smiths**
 - Smiths claim 40% whole life costs reduction to a comparable diesel vehicle
 - Purchase price for Smiths Newton 7.5t vehicle is between £78,000 and £81,000 for an 80kWh battery and 120kW motor
- **Modec**
 - Cost figures based on average 15,000 miles per year:
 - **Diesel Van:** 2008 £1.28 per litre x 4.27 = £5.76 per gallon ÷ 20 (mpg) = 29p per mile x 15,000 miles = £4,350 pa
 - **Modec Van:** Electricity 8.5p per kWh. 1.2 miles per kWh = 7p per mile x 15,000 miles = £1,050 pa
 - Modec vehicle cost around £25,000 but lease batteries to customers so they take care of maintenance and recycling

Technology Cost



While electric vehicles offer some benefits they are not suitable for all applications and may require modification to standard schedules

Safety and Limitations

- ✓ Faster acceleration in traffic
- ✓ No gear changes — perfect for stop-start applications, fewer gear changes and clutch movements equals less stress and fatigue for drivers
- ✓ Many components are 100% recyclable
- ✓ Lower service and maintenance requirements
- ✗ Vehicle charge time needs to be planned into daily operation schedule
- ✗ Training of maintenance staff to work safely with high voltage vehicle
- ✗ Uncertainty over the depreciation of vehicle values, with nominal residual values common
- ✗ Changes may be required in operating practices, as well as the installation of charging equipment
- ✗ Potential of reduced operating range in cold weather
- ✗ Manufacturers' warranties can vary
- ✗ Maximum vehicle GVW of 12t
- ✗ Lower payload of 3300kg at 7.5t GVW compared to a benchmark of 4200kg

Safety and Limitations



Technology Maturity

- There are now 4,000 registered electric vans in the United Kingdom but they are still new in their development cycle
- In the UK Smiths Electric Vehicles and Modec are two of the UK largest electric vehicle manufacturers
- The majority of electric commercial vehicles are light commercial vehicles
- Companies that have purchased and/or trialled Smith Newton vehicles include:
 - TNT Express
 - CEVA Logistics
 - Marks & Spencer
 - DHL
 - Royal Mail

Maturity

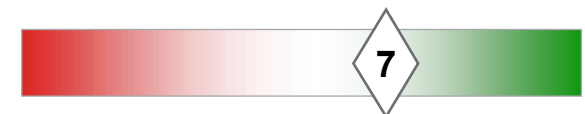

Stop / Start mild hybrids offer best CO₂ benefit for frequent stop / start applications and are currently only found on light vehicles

Hybrid Powertrains – Stop / Start Mild Hybrid

- **Concept:** Stop the engine running whenever the vehicle is stationary
- **Base Functioning:** System uses a high-voltage e-motor mounted to the crankshaft to operate stop / start, along with regenerative braking
- **CO₂ Benefit:** 0 – 30%, averaging around 6%, but very dependent on duty cycle. Duty cycle with frequent stop / start will obtain greatest benefit
- **Costs:** £545 as option for Mercedes Sprinter, likely to be more for larger vehicles

Safety and Limitations

- ✓ Simple solution which has no high voltage safety hazards
- ⊖ Not suitable for vehicle bodies which are engine powered when vehicle is stationary
- ⊖ Only suitable for urban applications with frequent stop/start

Technology Applicability

- Greatest CO₂ reduction potential for vehicles operating over an urban duty cycle

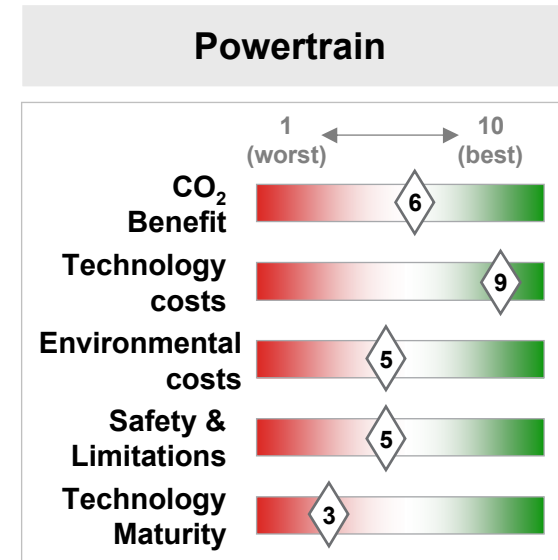

Visualisation



Picture: Ricardo HyTrans

Stop & Start mild hybrids have an engine mounted e-motor for engine stop-start operation

Technology Description

- Currently in the European market mild stop/start hybrids tend only to be found in lighter vehicle applications
- **Hybrid Components / System Description**
 - High voltage e-motor mounted on engine
 - Torque transmission path same as for base vehicle
 - Generation from FEAD or crankshaft connection
 - Engine stop/start at any vehicle speed, using e-motor
 - E-PAS and electric vacuum pump may be needed
 - Replaces 24V starter and alternator
- **Hybrid Functionality**
 - + Engine stop-and-start
 - + Stationary Generation (crankshaft)
 - + Regenerative braking – although less efficient due to engine rotation
 - + Mild torque assist possible

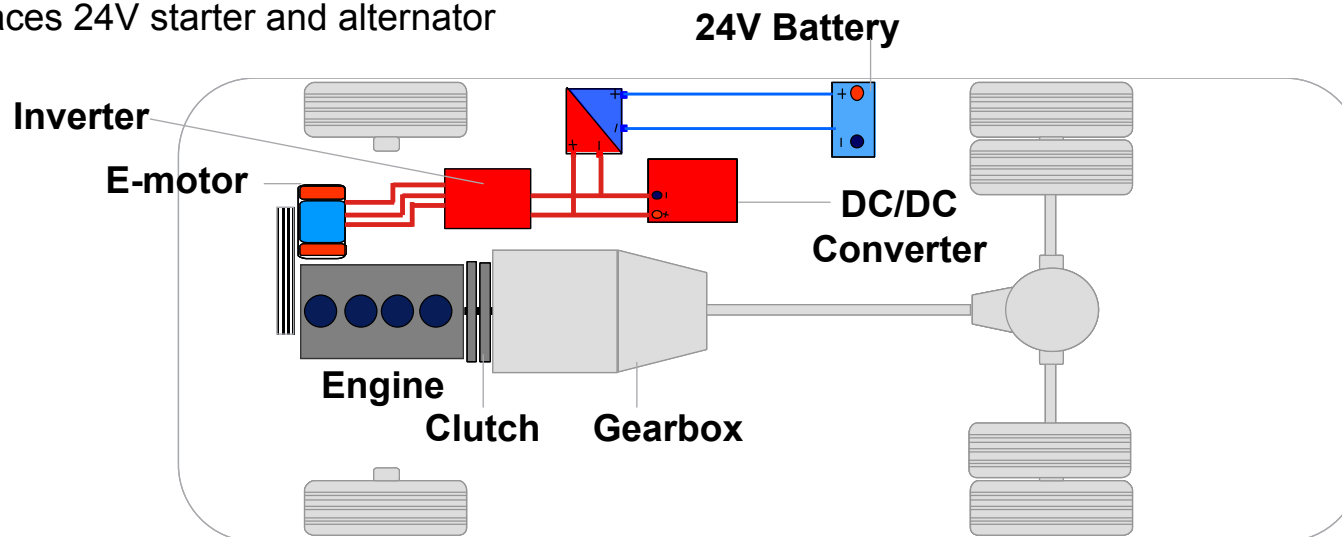

CO₂ benefit offered by stop / start systems is in the region of 6% but is very dependent on duty cycle

CO₂ Benefit

Ricardo HyTrans

- Fuel consumption benefit for the Ricardo HyTrans vehicle demonstrator was:
 - NEDC – 3.7%
 - UDDC 1 – 21.3%
 - UDDC 2 – 6.3%

Mercedes Sprinter

- Fuel consumption is claimed to show an improvement of at least 6% with the equipment, which is available on all 4-cylinder manual Sprinters

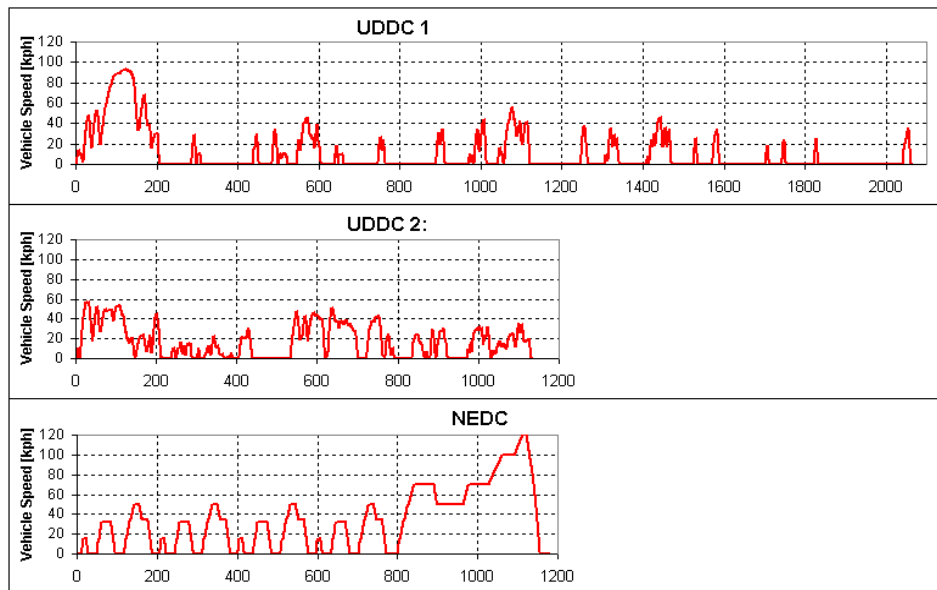

CO₂ Benefit

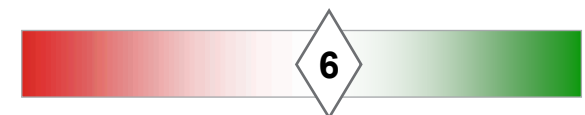

Stop/Start hybrid vehicles have lower environmental and economic impact than full hybrid systems



Technology and Environmental Cost

Technology

- Stop / Start is available on the Mercedes Sprinter Van at £545 more than the standard model, most of the additional cost goes toward the required special battery and starter-motor
- For HGV application, the system would cost more due to the increase in power requirements

Environmental

- Environmental impact of a stop / start system is minimal with slight increase due to manufacture of additional components

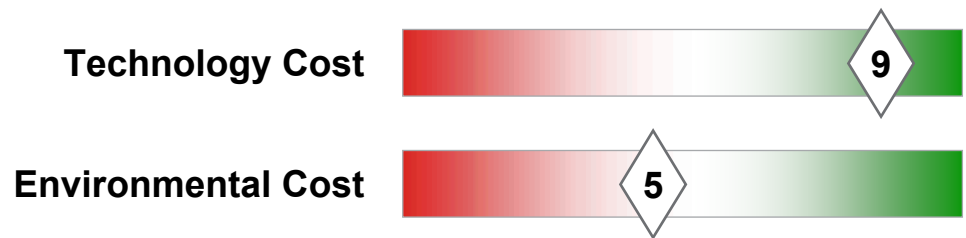

Stop/Start technology is widely available in other market sectors but is limited for HGV into very specific applications

Safety and Limitations

- ✓ Simple solution which has no high voltage safety hazards
- ✗ Not suitable for vehicle bodies which are engine powered when vehicle is stationary
- ✗ Only suitable for urban applications with frequent stop/start

Technology Maturity

- Stop/Start systems are a mature technology on light duty vehicles
- Such systems are widely available in the passenger car market and in some light commercial vehicles
- No known HGV application

Safety and Limitations



Maturity

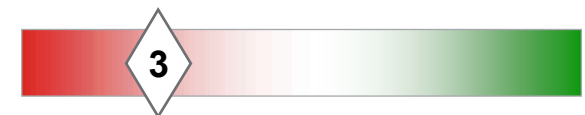

Hybrid Vehicles provide high potential CO₂ reduction for urban applications but are expensive and will require maintenance training



Hybrid Powertrains – Full Hybrid

- **Concept:** A powertrain which can use more than one fuel source to provide energy to propel the vehicle
- **Base Functioning:** Typically implemented as hybrid electric vehicles where electrical energy is stored in batteries which can be used to drive an electric motor to power the vehicle or supplement engine power
- **CO₂ Benefit:** Ranges significantly dependent upon vehicle operation but averages 20% for medium (urban) and 7% for heavy duty (long haul) applications
- **Costs:** Significant technology on cost of additional hybrid components. Some environmental impact in terms of battery manufacture and disposal

Safety and Limitations

- ✓ Lower brake wear due to use of regenerative braking – leads to lower maintenance costs
- ✓ Makes use of existing fuel infrastructure
- ✓ Vehicles have better acceleration
- ✗ Some vehicles have a reduction in payload
- ✗ Engine stop/start unsuitable for some applications
- ✗ Requires training of maintenance staff to safely work with high voltage systems

Technology Applicability

- Greatest CO₂ reduction potential for vehicles operating over an urban duty cycle
- CO₂ savings still possible for long haul applications but business case requires more consideration

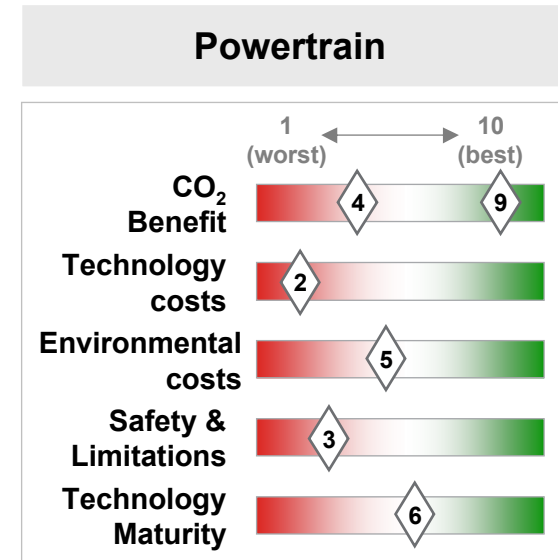

Visualisation



Picture: DAF LF Hybrid

Source: OEM corporate websites and press releases – Full sources available on detail slides in the attached annex

Full parallel hybrid systems are the most common hybrid electric vehicle architecture for heavy goods vehicles available in Europe



Technology Description

- There are a number of different hybrid vehicle configurations available. For heavy goods vehicles available in Europe, an inline full hybrid with gearbox mounted e-motor is the preferred solution
- **Hybrid Components / System Description**
 - High voltage e-motor integrated on gearbox input
 - High voltage battery and DC/DC converter
 - Torque transmission path same as for base vehicle
 - Generation from gearbox input, via clutch
 - Engine stop/start at any vehicle speed, using high voltage e-motor
 - EPAS, electric transmission oil pump and electric vacuum pump
- **Hybrid Functionality**
 - + Engine stop-and-start when stationary
 - Drive torque interrupted for engine start when moving
 - + Stationary Power Generation (HV and 24V)
 - + Regenerative braking – engine can be declutched for better efficiency
 - + Torque assist
 - Additional inertia on gearbox input requires smoothing torque from e-motor
 - + Electric vehicle/launch drive mode

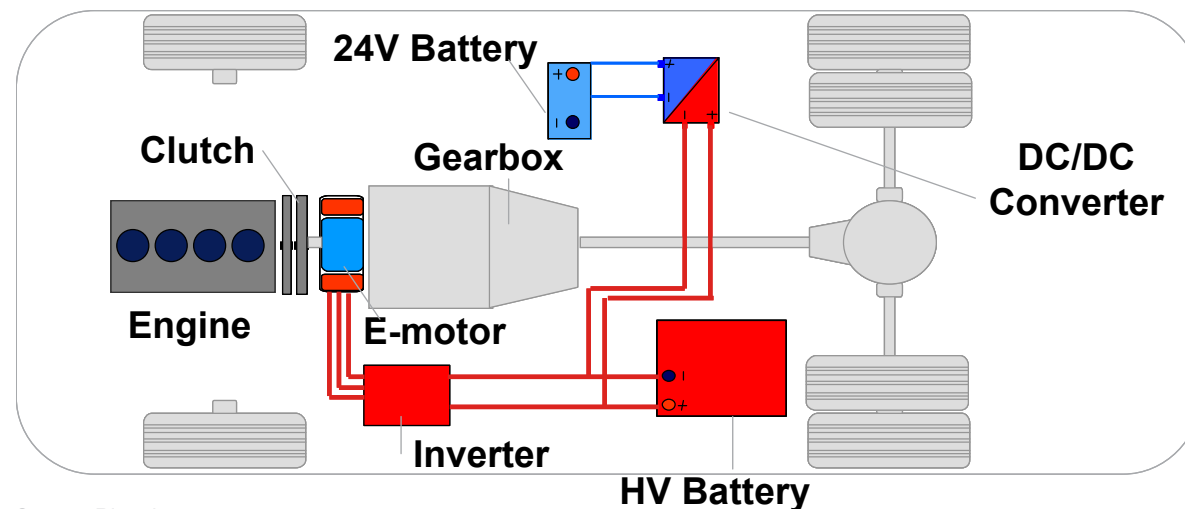

Source: Ricardo

The CO₂ benefit from hybrid systems varies greatly with duty cycle, higher at 20 – 30% for urban cycles and 4 – 10% for long haul

CO₂ Benefit

Medium Duty

- 30% reduction in CO₂ emissions is expected for Iveco EuroCargo, which is currently running trials with a 7.5t vehicle for TNT in Turin and a 12t vehicle for Coca Cola in Brussels
- DAF LF 7.5t hybrid is estimated to have a 25% - 30% reduction in CO₂ emissions and is currently undergoing real-world trials
- MAN estimate up to a 15% improvement in CO₂ emissions with the 12t TGL hybrid over a standard vehicle
- Mercedes Atego claims up to 20% reduction in CO₂ emissions for the 7.5t truck in regional delivery applications

Heavy Duty – Long Haul

- Mercedes-Benz Axor hybrid claims fuel savings and hence CO₂ savings of between 4% and 10% compared to a similar diesel Axor

Heavy Duty – Refuse & Distribution

- The Renault Hybrys based on the Premium Distribution platform is under trial in Lyon in real world refuse operation to assess if expected 30% reduction in CO₂ emissions can be achieved with a distribution vehicle due for trial by Coca Cola in July 2009 in Belgium where a 20% reduction in CO₂ emissions is expected
- Volvo FE Hybrid Test drives show up to 20% fuel consumption improvement for refuse collection applications (up to 30% if the superstructure, garbage compactor, is powered by an additional battery) and 15 – 20% for distribution applications
 - Trials are ongoing from 2009 to 2011



Source Iveco Press Release - Iveco and Coca-Cola Enterprises drive innovation with hybrid Eurocargo, March 2009, Iveco to begin limited hybrid production, SAE Automotive Engineering Online, 1st May 2009, available at <http://www.sae.org/mags/aei/vehic/6219> ; Hybrid Technology from DAF (http://www.daf.eu/UK/Trucks/Documents/hybrid_brochure_gb_jan09.pdf); MAN Press Release, September 23rd 2008; Daimler High Tech Report 1/2008; Renault Trucks Press Releases, Lyon, 20th August 2008, 11th September 2008; Volvo Corporate Website



Hybrid vehicles are expensive and although they bring environmental benefits in operation could be detrimental in manufacture and disposal

Technology and Environmental Cost

Technology

- Hybrid systems are currently still expensive additions to vehicles already containing a lot of expensive diesel aftertreatment technology
- Lithium-ion battery technology is \$2,000 / kWh now and in niche volumes which is forecast to reduce to \$1,000/kWh for high volumes of 100,000 per year and further to \$800 / kWh in 2020 for high volume
- Motor technology is between \$20 - \$40 /kW depending on volume plus an additional \$20 - \$40/kw for power electronics
- However due to the nature of operation, hybrid vehicles should bring lower repair and maintenance costs as regenerative braking is used in addition to standard brakes to slow the vehicle

Environmental

- Likely increased CO₂ emissions during vehicle manufacturing due to the additional equipment fitted to the vehicle
- Recycling of batteries will also contribute to lifetime CO₂ emissions
- Features include starting from a standstill in electric mode only, automatic starting of the diesel engine and additional power from the electric motor during acceleration, climbing and regenerative braking.
- Reduced emissions for urban usage along with quieter operation with vehicle operating partly in electric mode

Technology Cost



Environmental Cost



Hybrid vehicles are a reasonably mature technology that can help reduce maintenance costs, although vehicles can be limited in payload

Safety and Limitations

- ✓ Hybrid regenerative system can be used alongside exhaust brake or retarder to help reduce brake wear
- ✓ Lower maintenance and operating costs due to lower fuel consumption and wear on brakes and clutches
- ✓ Vehicles have better acceleration
- ✓ Makes use of conventional fuelling infrastructure
- ✗ Reduction in vehicle payload for some models due to the additional weight of components, for example;
 - Mercedes-Benz Axor hybrid weighs 155kg more than the non-hybrid variant, Iveco estimate 200kg lower payload and MAN 100kg compared to conventional variants
- ✗ Engine stop / start feature may be unsuitable for some vehicle body types which require ancillaries driven by the engine
- ✗ High voltage systems in vehicle requires training of service personnel such that safe modes of work are always observed

Technology Maturity

- Hybrid vehicles for urban medium duty applications are already available in market with others in final real world trials
- Heavy duty hybrids are much newer to market, although OEMs have good knowledge of the systems used
- Manufacturers with products in the market include DAF, Volvo and Mercedes-Benz

Safety and Limitations



Maturity

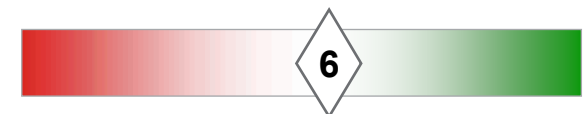

- **Feasibility Analysis**
 - Vehicle Technologies
 - **Powertrain Technologies**
 - **Engine Efficiency**
 - Waste Heat Recovery
 - Alternative Powertrains
 - **Transmissions**
 - Fuel Technologies

AMTs is a mature technology which offers good CO₂ reduction potential by keeping the engine in its optimum speed band

Transmissions

- **Concept:** Replacement of manual transmissions with automated variants
- **Base Functioning:** Automated transmission based on a manual (AMT) which has similar mechanical efficiency to a manual transmission but automated gear shifts to optimise engine speed
- **CO₂ Benefit:** 7 – 10% benefit replacing a manual with AMT
- **Costs:** Additional cost of £1,000 - £1,500 for an AMT over a manual

Safety and Limitations

- ✓ Optimum protection against external influences
- ✓ Increased service intervals
- ✓ Fast gearshifts which save fuel
- ✓ Extended clutch service life
- ✓ No limitations on vehicle usage
- ✓ No additional safety issues
- ✗ Shift quality is not as smooth as a torque converter automatic

Technology Applicability

- AMT technology is applicable to both medium and heavy duty applications, offering good CO₂ benefits over both urban and highway duty cycles
- DCT technology is not applicable to heavy duty and not applicable to UK medium duty market as it would result in a CO₂ penalty

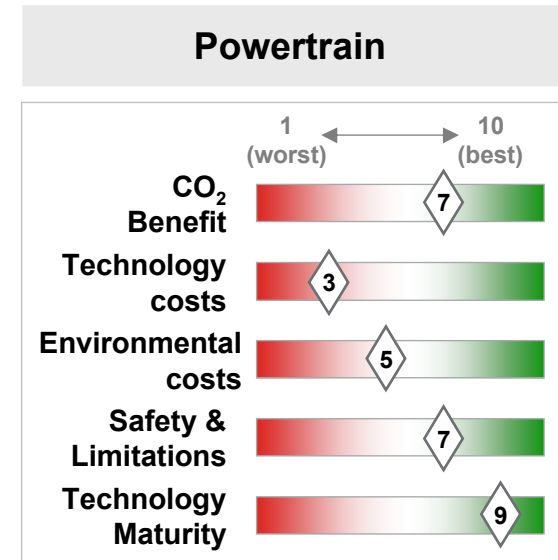

Visualisation

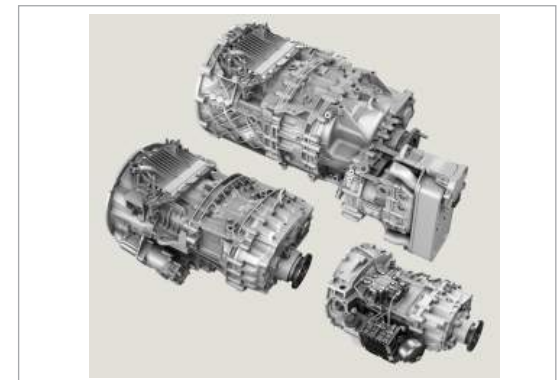

Picture: ZF AS-Tronic AMT Family (www.zd.com)

Automated transmissions considered are those based on the design of manual transmissions whose gear shifts are automated



Technology Description

Automated Manual (AMT)

- Automated manual transmissions are manual transmissions where gear shifts have been automated. The transmission uses a standard clutch and optimises the gear shift schedule to keep the engine operating in its most fuel efficient point

Dual Clutch Transmission (DCT)

- Dual clutch transmissions are dual layshaft transmissions, which have odd gears on one input shaft and even gears on the other. When the transmissions changes gear, torque is transferred from one clutch to the other. This improves shift quality over an AMT
- DCTs for HGVs will need to use wet clutches to achieve the torque levels required



**ZF AS-Tronic AMT
Family**



CO₂ benefit offered by AMTs ranges between 7 – 10%; DCTs are not applicable to HD and offer no benefit over a manual for MD

CO₂ Benefit

AMT

- For heavy duty applications an AMT is estimated to achieve 7% lower CO₂ emissions than a baseline manual
- For medium duty applications this is estimated to be around 10% lower CO₂ emissions
- Actual real world benefit will vary as the transmission will aim to be in the right gear at the right time and minimise shifts, which a good driver should do
- If drivers of manual transmission vehicles are trained via programs such as SAFED, real world benefit of AMT could be lower

DCT

- DCTs are not applicable to heavy duty trucks due to the large amounts of torque required
- For medium duty trucks, DCTs are most attractive to replace automatics in markets where automatics dominate
- In the UK where automatic transmissions are used for specific applications, a DCT would not be a suitable alternative
- To replace a manual transmission with a DCT would result in a fuel penalty and increase in CO₂ emissions



AMTs represent between 43 – 50% on cost over standard manual transmissions but can result in lower maintenance costs

Technology and Environmental Cost

Technology

- An AMT for heavy duty applications has an additional cost of circa £1,500 over a base manual transmission, which equates to a 43% on cost for heavy duty
- For medium duty the on cost is around £1,000, circa 50% on cost
- Through use of an automated transmission clutch wear can be reduced and service intervals increased, which will reduce operating costs over the vehicle lifetime

Environmental

- Aside from the benefit in lower fuel consumption, there will be a slight impact on environmental costs due to the manufacture of additional components used in the automation system
- However, benefits of the automated transmission are lower clutch wear and increased service intervals, which will reduce the amount of oil and clutches used over a vehicle lifetime

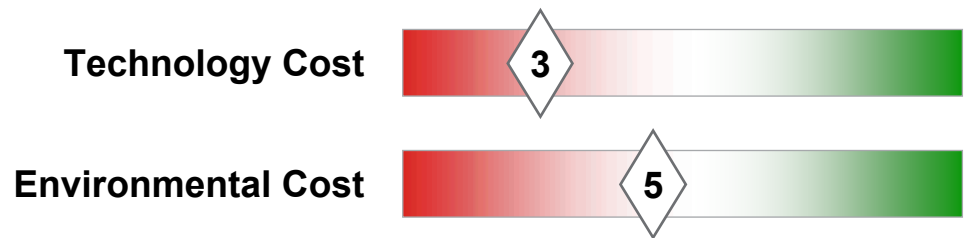

AMT technology is mature and well established in the market offering attractive benefits and no safety concerns

Safety and Limitations

- ✓ Optimum protection against external influences
- ✓ Increased service intervals
- ✓ Fast gearshifts which save fuel
- ✓ Extended clutch service life
- ✓ No limitations on vehicle usage
- ✓ No additional safety issues
- ✓ Increase ease of driving
- ✗ Shift quality is not as smooth as a torque converter automatic

Technology Maturity

- AMT technology is mature and in the market, with transmission offered by suppliers and OEMs
- Some OEMs offer AMT transmissions as standard equipment and others as options

Safety and Limitations

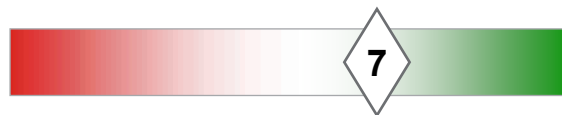

Maturity



- **Feasibility Analysis**
 - Vehicle Technologies
 - Powertrain Technologies
 - **Fuel Technologies**
 - Biofuel
 - Alternative Fuels

The roadmap for future fuels shows a diversification of fuels used for heavy duty on-highway applications

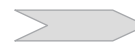

Europe: Technology Roadmap for Fuels

 Biofuels not considered
  Biofuels considered

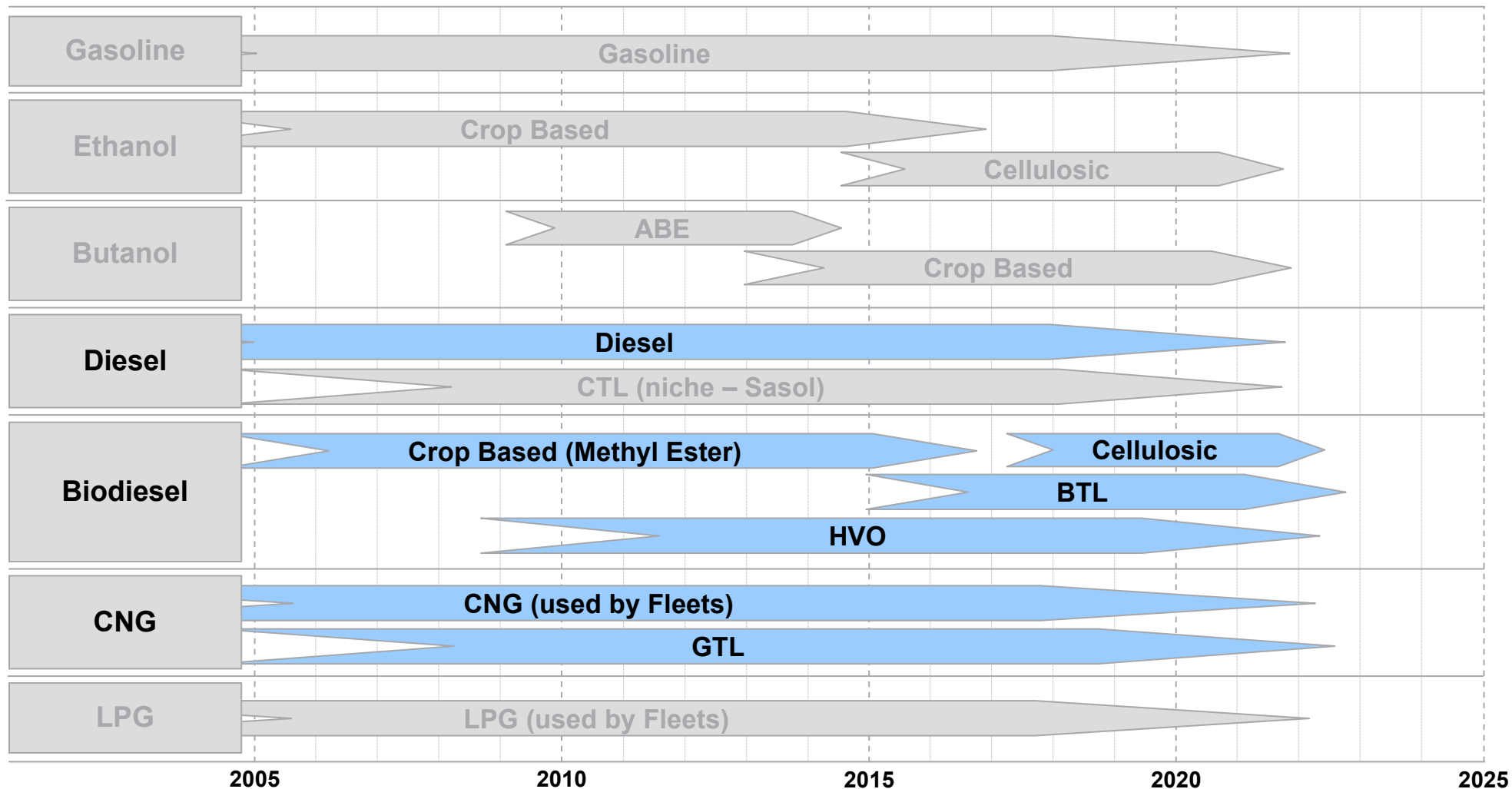

Source: Ricardo Analysis

Not all biofuels are equal in terms of WTW Energy and GHG emissions savings



WTW Energy Requirement and GHG Emissions

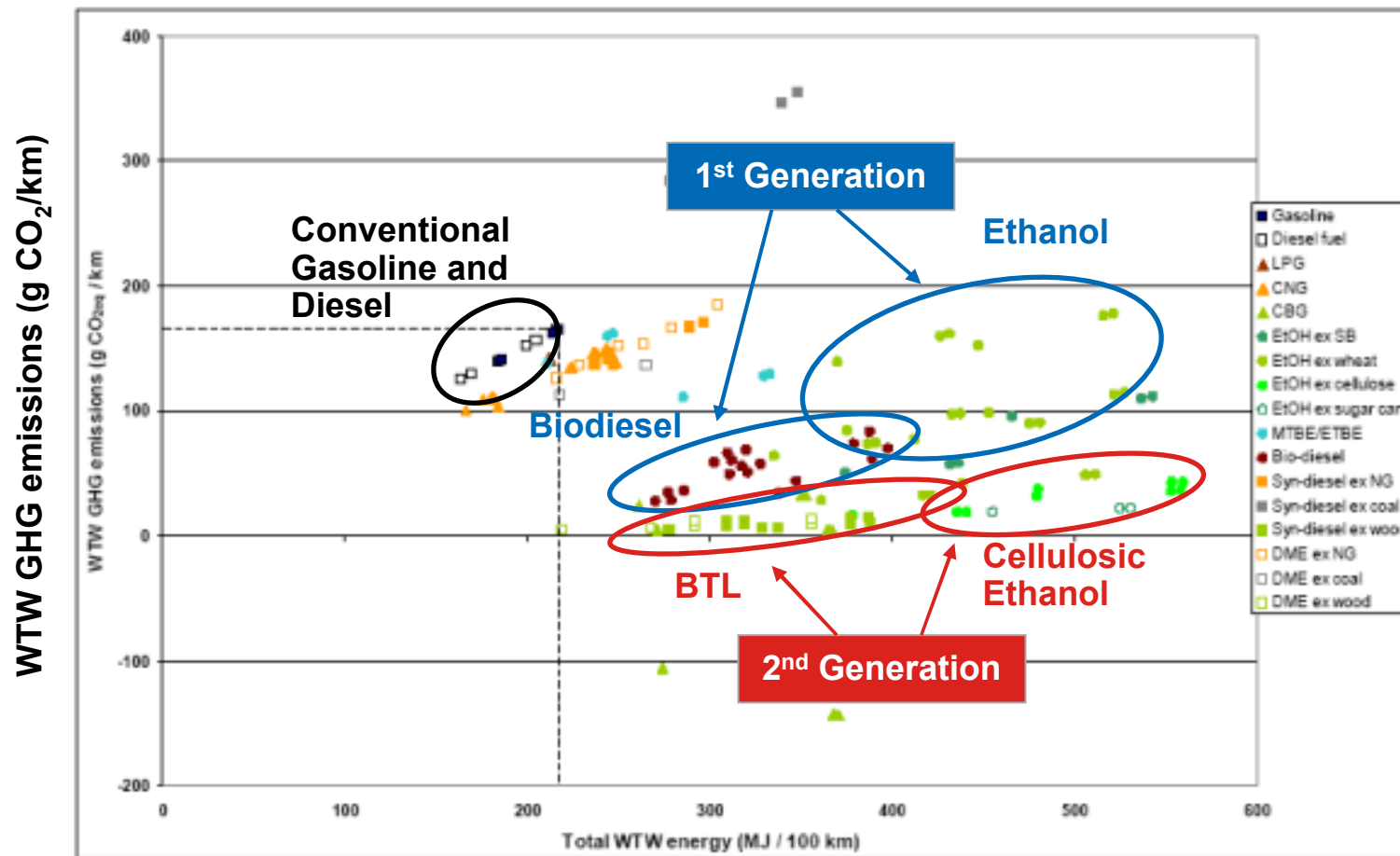

WTW Energy to travel 100km (MJ/100km)

WTW – Well to Wheels
GHG – Greenhouse Gas

Source: Well-to-wheels Analysis of Future Automotive Fuels and Powertrains in the European Context - EUCAR, CONCAWE and JRC

- **Feasibility Analysis**
 - Vehicle Technologies
 - Powertrain Technologies
 - **Fuel Technologies**
 - **Biofuel**
 - Alternative Fuels

FAME is a 1st generation biodiesel with the potential to reduce WTW GHG emissions



FAME

- **Concept:** 1st generation biodiesel derived from vegetable oils or animal fats and alcohols
- **Base Functioning:** FAME can be blended with conventional diesel to power engines. For higher blend ratios some modifications to the engine may be required
- **CO₂ Benefit:** Needs to be considered on WTW basis and depends on feedstock, country of origin and production process. In UK, potential GHG reduction ranges from -5 to 90%
- **Costs:** FAME is thought to be economically viable if oil is 80-100 \$/barrel

Safety and Limitations

- ✓ FAME has completed the health effects testing requirements of the 1990 CAA
- ✓ The use of biodiesel as a transport fuel does not require changes to the refuelling infrastructure
- ✗ FAME contains less energy per litre than conventional diesel
- ✗ Bio content as low as 5% can cause significant injection system deposits
- ✗ Low temperatures can cause waxing, clogged lines and filters

Technology Applicability

- FAME (1st Generation Biodiesel) is available, although quality varies due to the range of feed stocks and manufacturing processes
- FAME can be blended with conventional diesel to be used to fuel diesel engines, however there may be warranty issues if the blend is high

Source: Ricardo Analysis – Full sources available on detail slides in the attached annex

Fuel Technology

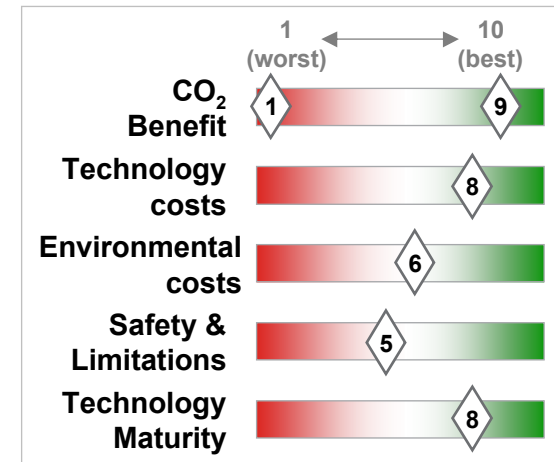

Visualisation



Picture:

Biodiesel (fatty acid esters) can be made from a number of different feed stocks through a chemical process called transesterification

Technology Description

- First generation biodiesel is defined as mono-alkyl esters of long chain fatty acids derived from vegetable oils or animal fats and alcohols. These conform to ASTM D6751 specifications for use in diesel engines.
- FAME (Fatty Acid Methyl Ester) is the common name for fatty esters produced with methanol. It is made through a chemical process called transesterification. In the process glycerin is separated from the feedstock vegetable oil or fat. The process produces fatty acid esters (the chemical name for biodiesel) and glycerol (a valuable by-product usually sold to be used in soaps and other products).
- FAME can be manufactured from a number of feed stocks, such as Rapeseed oil, Sunflower oil (Europe), Soybean oil (USA), Palm oil and Jatropha

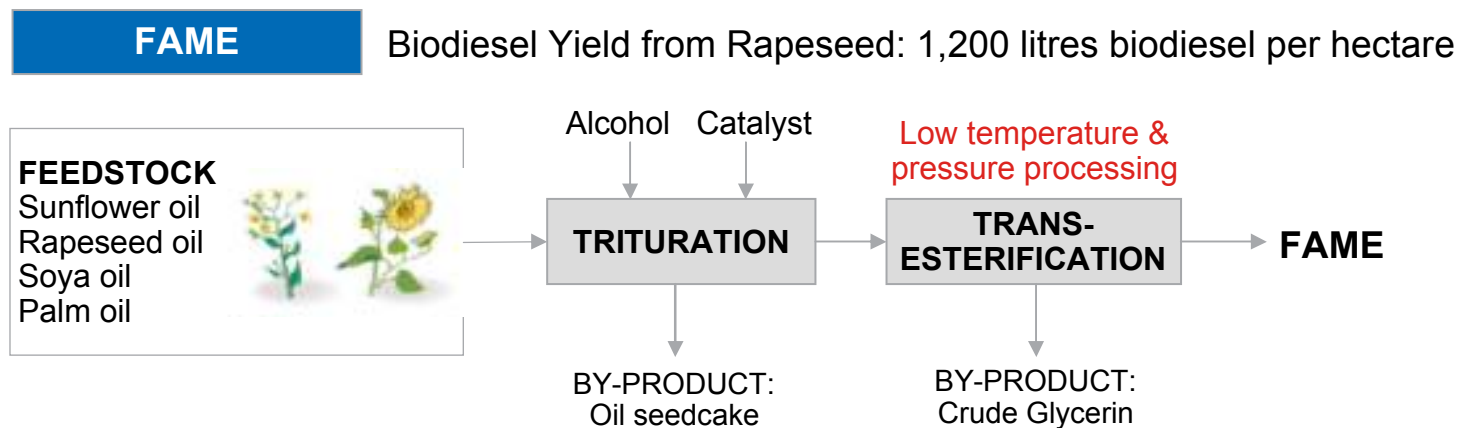

Currently UK imports most of the feedstock used to make biodiesel, with soybean and oilseed rape being the most popular



- In UK the most widely reported source for biodiesel is soybean imported from USA, followed by oilseed rape imported from Germany
- Currently only 6% of biodiesel feedstock is sourced from UK. The rest is imported from other countries

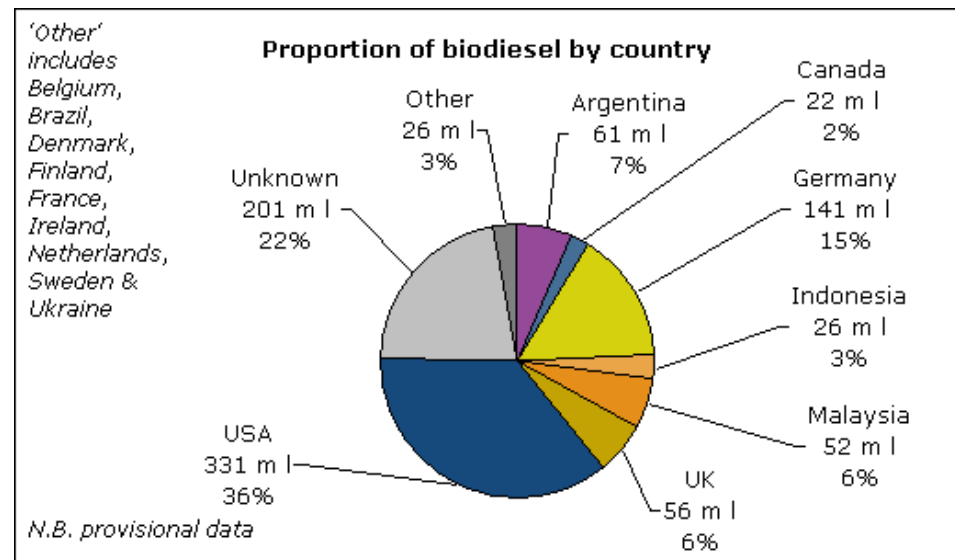
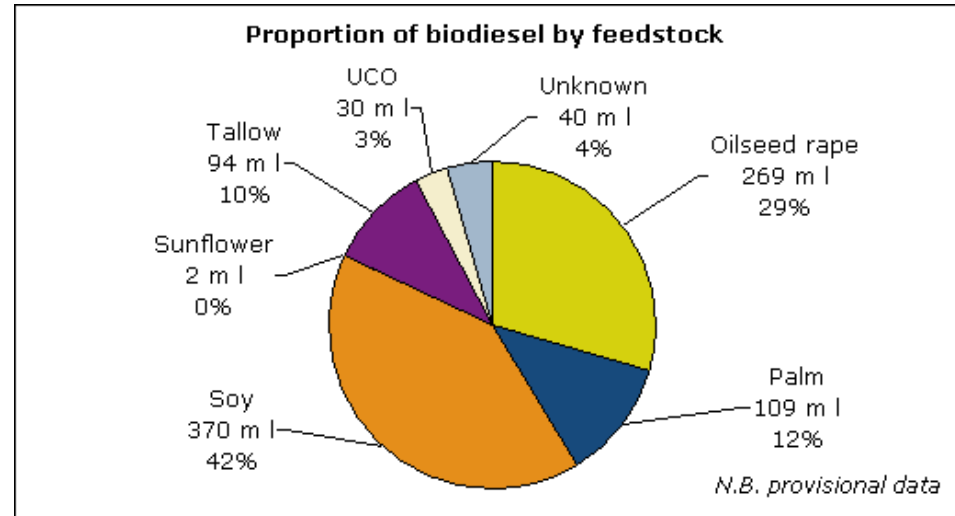

Pictures: UK RTFO monthly reports, April 2008 – February 2009

The differences in chemical and physical properties between biodiesel and regular diesel can cause potential problems

- The table below shows the potential problems associated with using FAME Biodiesel fuels, as a result of differences in their chemical and physical properties to those of regular diesel

Property (DIN EN 14214)	Effect / Evaluation
Density @15°C	Incorrect injection amount of fuel
Kinematic viscosity @40°C	Pumping problems (fuel pump, injection pump)
Cold filter plugging point (CFPP)	Problems in cold periods
Water content	Corrosion, clouding (mixtures Diesel/FAME), fall out
Total contamination	Filter plugging, also harmful for injection pump
Oxidation stability	Filter plugging, deposition of polymers in case of mixtures (Diesel/FAME) ^e
Acid number	Corrosion
Mono-, di- and triglycerides	Formation of coke
Free glycerol	Formation of coke
Iodine number	Fatty acid profile
Alkaline content (Na + K)	Filter plugging
Earth alkaline content (Ca + Mg)	Filter plugging (effect higher than alkaline)

- The iodine number is a measure of the double bonds in the fatty acid portion of biodiesel
- Biodiesel fuels have a lower Net Heat of Combustion than conventional diesel, as a result BSFC is higher.
- Recent studies on a modern 1.9L diesel engine have shown that
 - Higher engine efficiency (due to oxygen in the fuel improving combustion and the higher cetane number for the fuel)
 - Lower full load performance if injection strategy is not optimised for the lower net heat of combustion
- Other studies generally show a reduction in Hydrocarbon, CO and PM emissions and an increase in NOx emissions when using Biodiesel.

To realise the CO₂ benefit in using FAME, GHG emissions across the fuel life cycle must be considered



CO₂ Benefit

- The CO₂ emissions produced by running an engine on biodiesel are nearly equivalent to running the engine on diesel. Therefore to see the CO₂ benefit in using this fuel, analysis of the Well-to-Wheels must be considered.
- The GHG savings that can be achieved Well-to-Tank (i.e. production of the biodiesel) depend greatly on the feedstock, country of origin and production process used

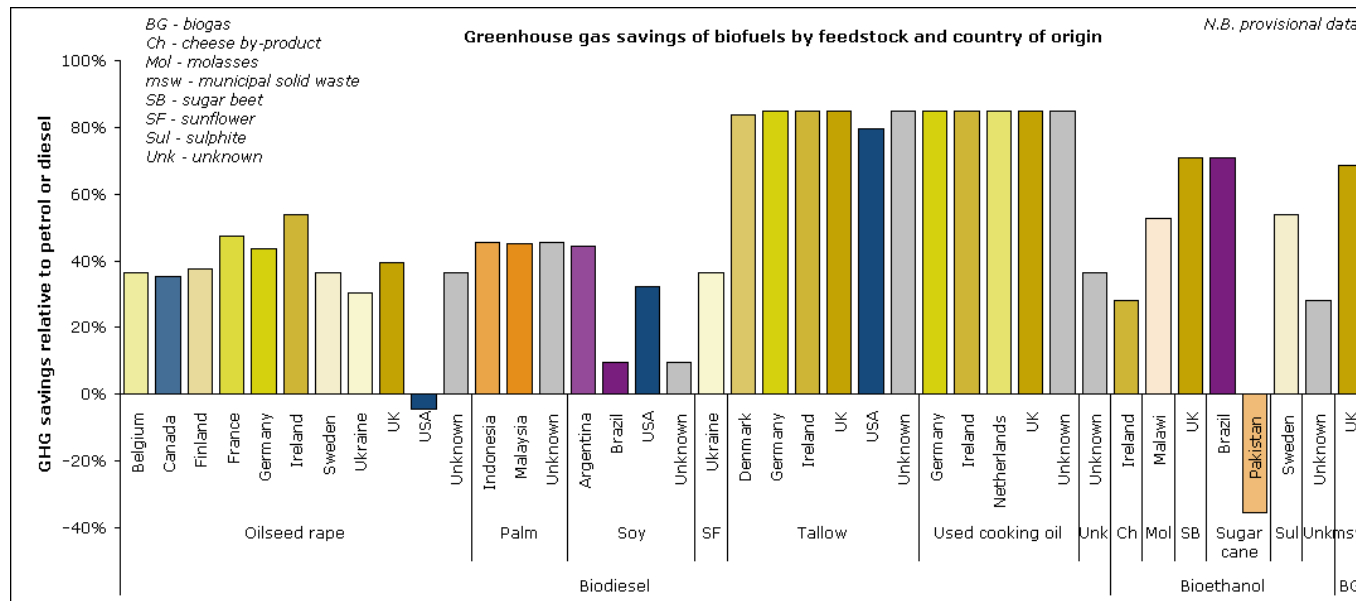

In UK, GHG savings from producing biofuels vary widely

Picture: UK RTFO monthly reports, April 2008 – February 2009 – Source-to-Tank GHG savings for biofuels produced from different feedstocks



As oil prices increase, FAME becomes competitive, however concern over its indirect environmental impact suggests caution



Technology and Environmental Cost

Technology

- FAME is thought to be economically viable if oil is 80-100 \$/barrel

Environmental

- The environmental impact of producing biodiesel can be divided into direct and indirect effects
 - Direct effects include the energy required to produce the biodiesel and the emissions associated with this energy use.
 - For most biodiesel energy chains, the direct environmental impacts are lower than for diesel production
 - Indirect effects may include displacement of existing agricultural production, and rising food prices
 - Following recommendations in the 2008 Gallagher Review (The Gallagher Review, July 2008), the UK Government has legislated to slow down the rate of increase of biofuels supplied for road transport in the UK, to allow for a fuller understanding of these indirect impacts to be reached
- When used in diesel engines, FAME usually helps to reduce SOx emissions, but increases NOx emissions

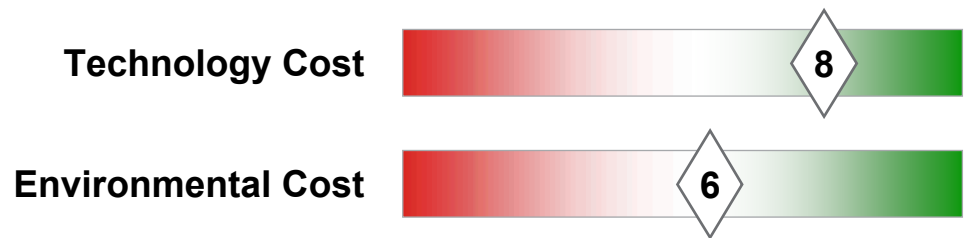

FAME can be safely blended with diesel in low concentrations, however higher blends may have more issues

Safety and Limitations

- ✓ FAME can be blended with petroleum based diesel fuel. Blended in low concentrations (currently up to 5%), biofuels can be used safely in existing diesel vehicles without modifying the engine. Some modifications to the engine may be required for higher blends of biofuel (e.g. B100).
- ✓ It has completed the health effects testing requirements of the 1990 Clean Air Act Amendments
- ✓ The use of biodiesel as a transport fuel does not require any changes in the distribution system, therefore avoiding expensive infrastructure changes
- ✗ However there are some potential issues with its use, particularly concerning compatibility with existing injection systems
- ✗ FAME contains less energy per litre than conventional diesel
 - 1L 100% FAME is equivalent to the energy content in 0.92L of Diesel
- ✗ Low temperatures can cause waxing, which may lead to gelled fuel or clogged lines and filters. This limits the use of FAME during cold climates.

Technology Maturity

- FAME (1st Generation Biodiesel) is available
 - Quality varies due to the range of feed stocks and manufacturing processes
- Since the characteristics of FAME depend on the feed stock and blend ratio with standard diesel, it is difficult to future-proof engines to be capable of running on all the combinations of this fuel
 - In NAFTA most OEMs approve biodiesel up to 5% blends (B5) provided it conforms to the ASTM or EN standards
 - Many of the main manufacturers of off-highway equipment in Germany warrant their products with B100. However, these engine do not have advanced aftertreatment.
 - OEMs that will warrant their engines to run on B100 will require shorter service intervals, for example more frequent oil and filter changes (e.g. Scania)

Safety and Limitations



Maturity

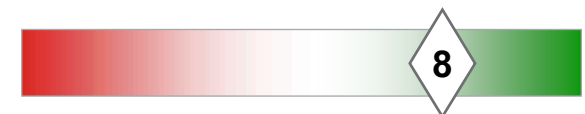

BTL is a 2nd generation biodiesel that can be produced to waste, thus leading to GHG reductions



BTL

- **Concept:** 2nd generation biodiesel produced by converting Biomass to Liquid (BTL)
- **Base Functioning:** BTL can be run in any diesel engine
- **CO₂ Benefit:** 60-90% on WTW basis, depending on production scenario
- **Costs:** Expected to be more expensive than 1st generation biodiesel since the production process is more energy intensive

Safety and Limitations

- ✓ BTL has potentially better fuel characteristics (effectively synthetic diesel)
- ✓ BTL can be used without any adjustment to existing infrastructure or engine systems,
- ✗ However this relatively new fuel needs to be proven on an industrial scale

Technology Applicability

- Since BTL is a synthetic diesel, it will be possible to use it to fuel all diesel vehicle without modification
- BTL is not currently commercially available, although a beta-test production plant is under construction in Germany

Fuel Technology

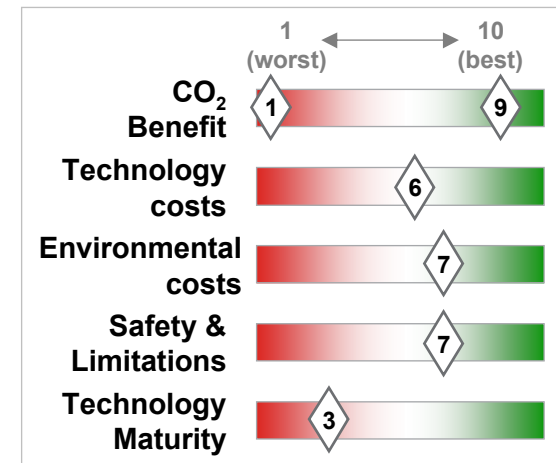

Visualisation



Picture: Choren

BTL is a 2nd Generation Biodiesel that can be produced from a biomass feedstock



Technology Description

- Biomass to Liquid (BTL) is a 2nd Generation Biodiesel
- The feedstock is any biomass (waste), e.g. wood, etc.
- Choren produce a BLT fuel which is marketed as “SunDiesel”. This fuel is produced from the gasification of wood waste, using Choren’s Carbo-V process, followed by Fischer-Tropsch synthesis
- The product is similar to GTL fuels, with the advantage of being produced from a renewable source
- It is estimated that over 4m³ of BTL fuels can be produced per hectare of land per annum. Hence, in the future 4-6 million hectares of land used to grow energy crops could replace 20-25% of the liquid transport fuel currently used

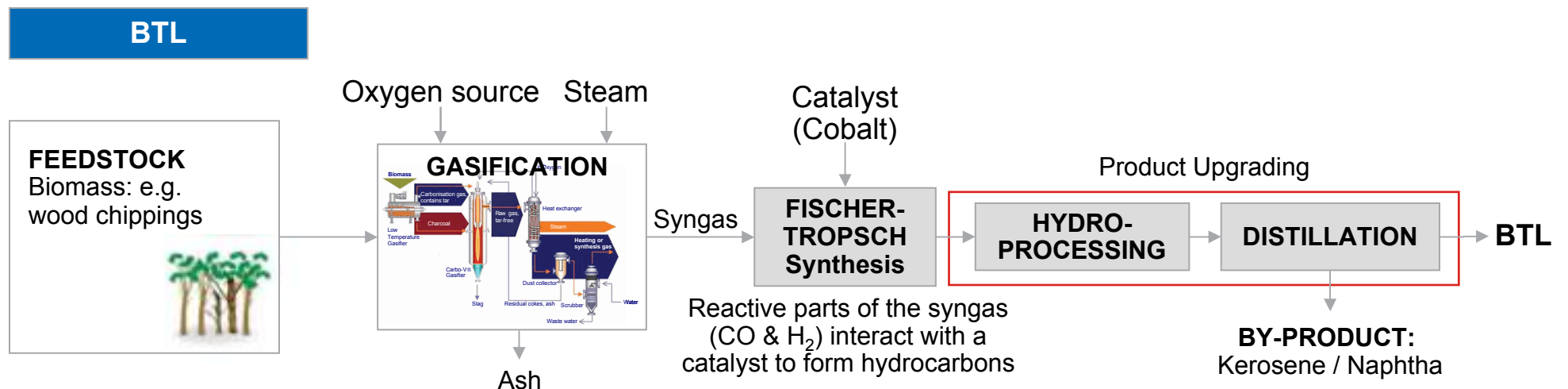

Source: Ricardo Analysis, Choren www.choren.com; Biofuels Technology Platform

BTL has the potential to reduce GHG emissions by 60-90% on WTW basis compared to conventional diesel



CO₂ Benefit

- Since BTL is a type of synthetic diesel, the CO₂ emissions produced when running a vehicle on BTL are very similar to the CO₂ emissions emitted when running the vehicle on diesel
- As for FAME, the CO₂ benefit must to evaluated an a Well-to-Wheel basis
- A life cycle assessment study by PE International for Choren found that the greenhouse gases potential (kg CO₂ equivalent) of SunDiesel was 60-90% lower than conventional diesel, depending on the production scenario

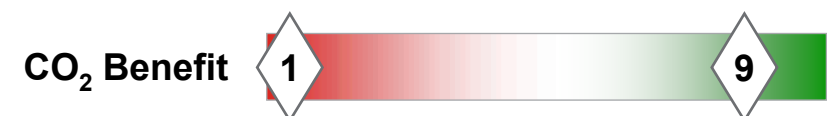

It is expected that BTL will have higher production costs but lower environmental impact than 1st generation biodiesel



Technology and Environmental Cost

Technology

- The current estimate is that BTL will have higher production costs than for FAME

Environmental

- BTL is in less competition with food crops than FAME, since the process uses non-food crops enabling a wider range of biomass feed stocks than just the oils, sugars and starch components
- Lower land use than FAME, since BTL can be made from waste agricultural material
- Significant fossil energy savings (better than 1st generation biodiesel), when compared on WTW basis
- Improvements in GHG emission reduction – better than 1st generation (use different processes)
- But, BTL requires an energy intensive production process

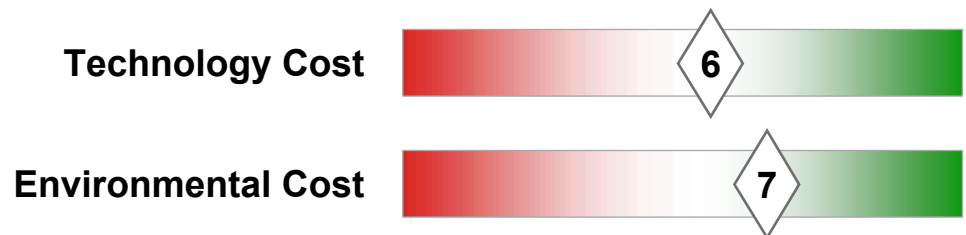

BTL has the potential to have better fuel characteristics than conventional diesel, but is not yet commercially available

Safety and Limitations

- ✓ BTL has potentially better fuel characteristics (effectively synthetic diesel)
 - It has a high cetane number and therefore much better ignition performance than conventional diesel fuel
 - It has no aromatics or sulphur
 - Its energy per litre is similar to conventional diesel
- ✓ BTL can be used without any adjustment to existing infrastructure or engine systems
- ✓ BTL can be made of any biomass feedstock
- ✗ However, BTL is a relatively new fuel and is not yet been prove on an industrial scale

Technology Maturity

- Not yet commercially available, but there are several pilot plants producing BTL
 - Choren (SunDiesel), in partnership with Shell, is the main player
 - VW and Daimler have expressed interest in BTL

Safety and Limitations

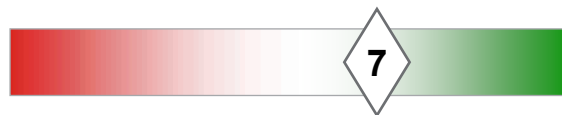

Maturity



HVO is a 2nd generation biodiesel made by hydro-treating vegetable oils



HVO

- **Concept:** 2nd generation biodiesel made by treating vegetable oil or animal fat with hydrogen
- **Base Functioning:** HVO can be used to fuel any conventional diesel vehicle
- **CO₂ Benefit:** 40-60% WTW GHG reductions compared to conventional diesel
- **Costs:** It is expected that HVO will be more expensive than 1st generation biodiesel

Safety and Limitations

- ✓ HVO has potentially better fuel characteristics (effectively synthetic diesel)
- ✓ HVO can be used without any adjustment to existing infrastructure or engine systems
- ✗ However, HVO is a relatively new fuel and is not yet been prove on an industrial scale

Technology Applicability

- HVO can potentially be used to fuel any diesel vehicle
- HVO is commercially available in Finland, as a 10% blend in Neste Oil's Green Diesel

Fuel Technology

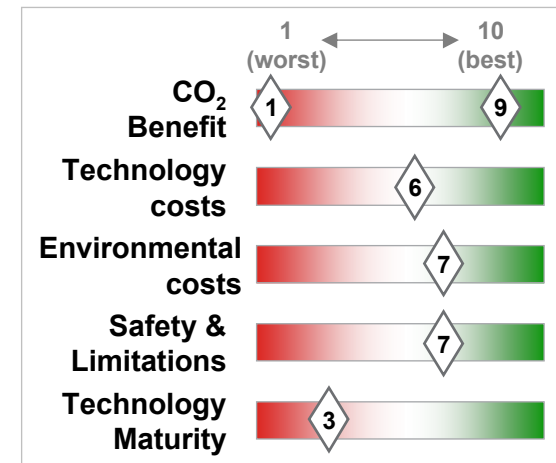

Visualisation



Picture: Neste Oil

Like FAME, HVO can be made from a range of feedstocks



Technology Description

- Hydrogenated Vegetable Oil (HVO) is a 2nd generation biodiesel
- Like FAME, HVO can be made from a range of feedstocks



Picture: Neste Oil, HVO production plant in Finland

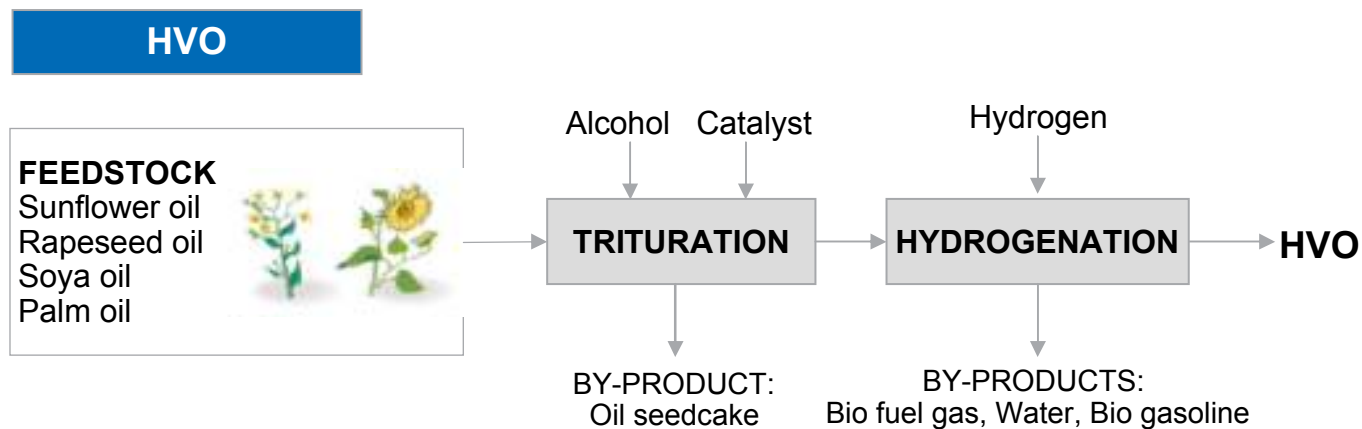

HVO has the potential to reduce GHG emissions by 40-60% on WTW basis compared to conventional diesel



CO₂ Benefit

- As for FAME and BTL, the CO₂ benefit in using HVO instead of conventional diesel must be assessed on a Well-to-Wheel basis
- Neste Oil claim that their HVO product currently delivers 40-60% GHG reductions compared to conventional diesel
 - The majority of these emissions are generated during the production of the raw material. Therefore there is the potential to reduce GHG emissions by optimising the use of fertilisers, waste water treatment and use of waste.

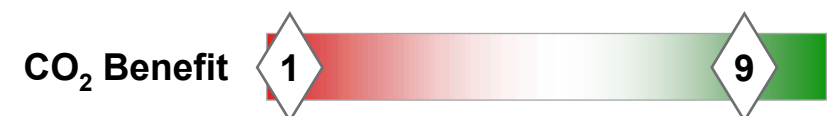

Like BTL, HVO is expected to have higher production costs but lower environmental impact than 1st generation biodiesel



Technology and Environmental Cost

Technology

- It is expected that HVO will have higher production costs than FAME

Environmental

- Since HVO is a type of synthetic diesel, there is potential to reduce engine-out emissions, which would contribute to improving local air quality

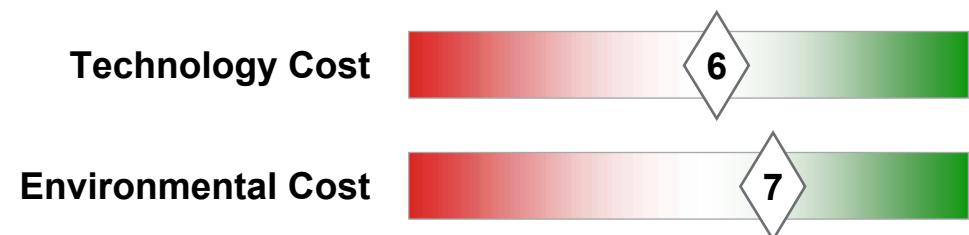

HVO is currently available in Finland as part of a diesel blend



Safety and Limitations

- ✓ HVO has potentially better fuel characteristics (effectively synthetic diesel)
 - It has no aromatics or sulphur
 - Its energy per litre is similar to conventional diesel
- ✓ HVO can be used without any adjustment to existing infrastructure or engine systems
- ✗ However, HVO is a relatively new fuel and is not yet been prove on an industrial scale

Technology Maturity

- Neste Oil produce a HVO Biodiesel fuel which they market as NExBTL.
 - Neste currently have one NExBTL plant operating in Finland
 - They plan to open a second plant in Finland in 2009, and a plants in Singapore and Rotterdam in 2011
 - Neste Green diesel, which contains 10% NExBTL, was launched in Finland in May 2008

Safety and Limitations



Maturity

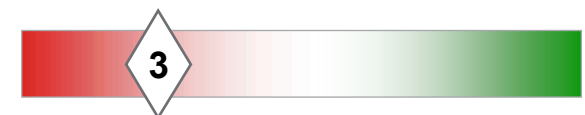

- **Feasibility Analysis**
 - Vehicle Technologies
 - Powertrain Technologies
 - **Fuel Technologies**
 - Biofuel
 - **Alternative Fuels**

Running heavy-duty engines on CNG could have a 10-15% CO₂ benefit, but lack of infrastructure restricts use to fleets

CNG

- **Concept:** Spark ignited CNG variants on base diesel engines
- **Base Functioning:** Injection of gas into intake and combustion initiated with spark
- **CO₂ Benefit:** 10-15%
- **Costs:** Low volume production means the retail price for CNG engines is 20-25% higher than the equivalent diesel engine
- Several OEMs are developing CNG engines, although these tend to be for fleet applications such as buses and refuse trucks rather than HGVs

Safety and Limitations

- ✓ CNG has been used safely in many automotive applications worldwide
- ✓ CNG engines are most appropriate to urban fleets, such as buses
- ✗ Public access to the CNG refuelling infrastructure is currently limited
- ✗ CNG leaks can cause explosions and fire

Technology Applicability

- Buses
- Trucks
- Stationary engines

Fuel Technology

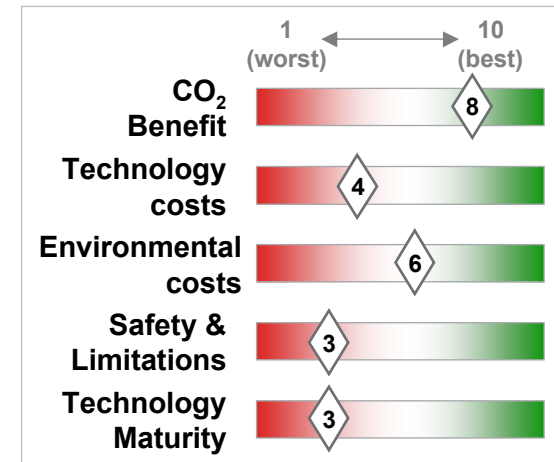

Visualisation



Picture:

CNG can be used to fuel heavy-duty applications in either single-fuel, CNG spark ignition engines or dual fuel Diesel-CNG engines



Technology Description

Spark Ignition CNG Engines

- A spark ignited gas engine is typically converted from the diesel engine base, comprising of the following main modifications:
 - Spark plug in place of the injector
 - Reduced compression ratio
 - Different valve and seat materials
 - Throttle
 - Gas injection into intake system
 - Improved air control
 - Different engine management system
- Two combustion modes from gas engines are present in the market place:
 - Lean Burn
 - Lambda 1 (stoichiometric)

Both combustion approaches have been shown to be capable of meeting Euro 5 and EEV limits. Although it is expected that lambda 1 engines will predominate in the future.
- The lambda 1 engines utilise a three way catalyst as in passenger cars. Cooled EGR is also needed to:
 - Reduce engine out NO_x
 - Improve knock tolerance
 - Reduce exhaust and combustion temperatures

Dual Fuel Diesel-CNG Engines

- In dual fuel engines diesel pilot injection is used as the ignition source for pre-mixed air and gas
- The mode of combustion allows for very lean combustion without any change to the base diesel engine. This allows the engine to switch to 100% diesel operation if CNG is unavailable, thus making it less dependent on infrastructure availability
- Current applications are retro-fit conversions, though there is some OEM interest
- The main components for the conversion are:
 - Gas delivery system
 - Air flow control system
 - EMS, 'piggy back' or dedicated
- Dual Fuel engines have been proven to US2007, but only NMHC considered unlike Euro 5
- Dual Fuel retro-fit need to be compliant with OBD, so only OEM fit will be possible in the future
- Euro 5+ emissions are possible, but may require addition/modified emission control systems

CNG does offer a CO₂ reduction compared to diesel technology, but this benefit is being compromised to meet future NOx emissions



CO₂ Benefit

Spark Ignition CNG Engines

- The CO₂ benefit over a diesel engine application depends on the concept and emissions level.
- Typically the benefit compared to a Euro 5 Diesel engine is a 10-15% CO₂ reduction. This arises from the very low carbon content and high energy content of natural gas
- Traditionally lean burn engines have had even greater CO₂ benefits compared to diesel. However at Euro 5 fuel efficiency is comprised to achieve the NOx emissions, making the CO₂ reduction similar to lambda 1 engines
- Future emission levels dictating further reductions in NOx will require:
 - Lambda 1 engine to reduce engine out NOx with increased EGR
 - Lean burn to use lean aftertreatment such as LNT or SCR
- These developments are likely to result in a further 0-5% reduction in CO₂ compared to Euro 5 engines

Dual Fuel Diesel-CNG Engines

- The precise CO₂ benefit is difficult to estimate in European context, but claims are in the region of 10-20%

CO₂ Benefit

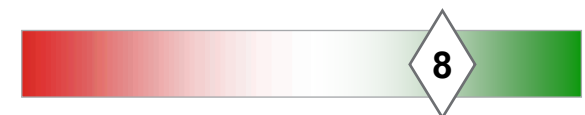

Due to low production volumes, CNG engines retail at a higher price than conventional diesel engines



Technology and Environmental Cost

Technology

- The piece cost of a CNG engine (including EMS and catalysts) is approximately 10-15% lower than the diesel equivalent
- This excludes any amortisation of the development costs which can be quite high given the current low volume niche for CNG engines
- CNG vehicles require a storage tank for the compressed gas
- Commercial pricing indicates a CNG vehicle is 20-25% more expensive at current volumes

Environmental

- Most CNG is produced from non-renewable resources, although in some regions this could be supplemented by renewable sources, such as biogas.
 - The renewable sources need to undergo further processing to increase the quality of the gas for transport use, and therefore have higher production costs than non-renewable sources
- CNG engines produce much lower particulate emissions than diesel engines
- CNG engines are quieter than diesel engines, making them particularly suited to urban environments
- Since methane, the main constituent of natural gas, is a potent GHG (21 times the Global Warming Potential of CO₂) and since natural gas mixed with air can burn easily in the presence of a flame, leak prevention is a vital consideration

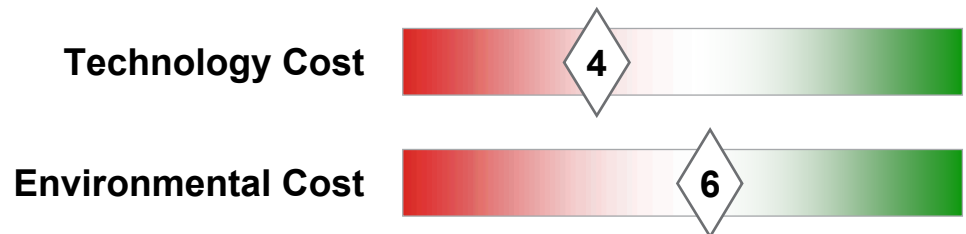

CNG engines have been used safely for around 30 years in fleet applications such as buses and refuse trucks

Safety and Limitations

- ✓ CNG has been safely proven in many applications worldwide
- ✓ CNG engines can be used in nearly all applications instead of diesel engines
- ✓ CNG engines are most appropriate to urban fleets, such as buses
- ✗ Public access to the CNG refuelling infrastructure is currently limited
- ✗ The gas needs to be doped like domestic supplies to enable detection by smell
- ✗ CNG leaks can cause explosions and fire

Technology Maturity

- Spark ignition CNG engines have been around for over 30 years, though present day technology requirements are much more sophisticated
 - Applications include buses and refuse trucks
 - CNG engines have not yet been used in HGVs
- The main emissions related technologies for lambda 1 engines, such as catalysts and engine management systems, use derivatives of very mature gasoline engine systems
- Lambda 1 engines with three way catalysts and cooled EGR have been available at EEV since 2000
- Lean burn engines will require LNT or SCR technologies for Euro 6. These technologies are relatively immature but are being developed in diesel applications

Safety and Limitations



Maturity

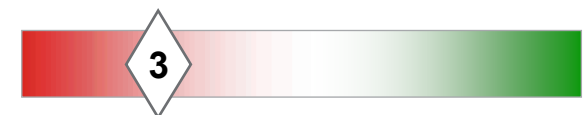

Biogas can be used to power vehicles in a similar way as CNG, with a similar price and less impact on the environment

Biogas

- **Concept:** Upgraded biogas, made from organic material, used to fuel vehicles
- **Base Functioning:** Biogas upgraded to 95% methane can be used instead of natural gas to power engines. Like CNG engine, the gas is injection of gas into intake and combustion initiated with spark
- **CO₂ Benefit:** Current studies claim 60% CO₂ benefit when compared to diesel vehicle
- **Costs:** A new biogas heavy goods vehicles could be around £25,000 to £35,000 more expensive, whilst new biogas vans cost approximately £4,000 to £5,000 more.

Safety and Limitations

- ✓ Biogas can be used safely to fuel any vehicle, following the same precautions followed for natural gas fuelled vehicles
- ✗ The uptake of biogas as a road fuel requires the development of a national production and distribution infrastructure

Technology Applicability

- Upgraded biogas (95% content methane) could be used in any vehicle designed to run on natural gas

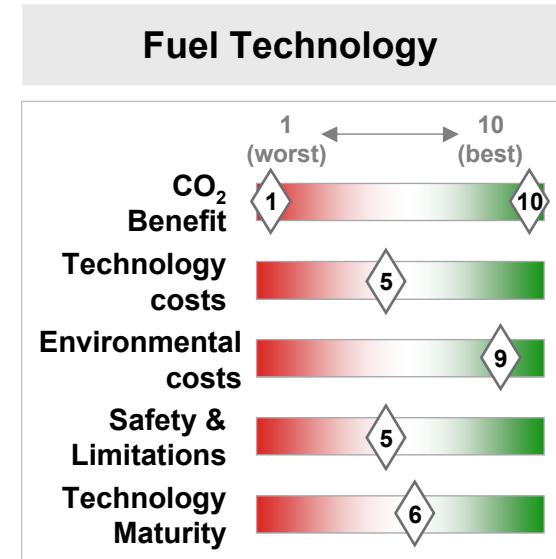

Visualisation

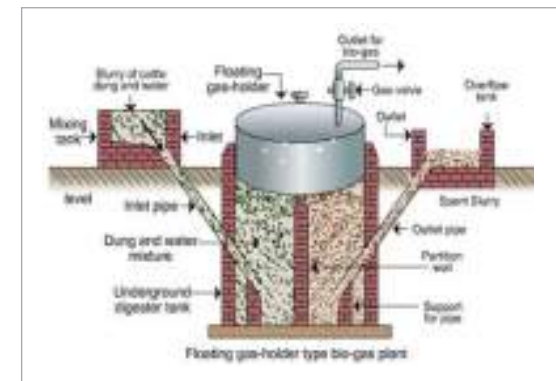

Picture:

Biogas is a renewable alternative fuel produced by anaerobic digestion of organic material

Technology Description

- Biogas also known as Liquid Biomethane (LBM) is a renewable alternative fuel which is produced by breaking down organic matter by means of anaerobic digestion (decomposition without oxygen)
- Biogas is normally formed from one of the following streams:
 - Sewage treatment plants
 - Landfill waste sites
 - Cleaning of organic industrial waste streams
 - Digestion of organic waste

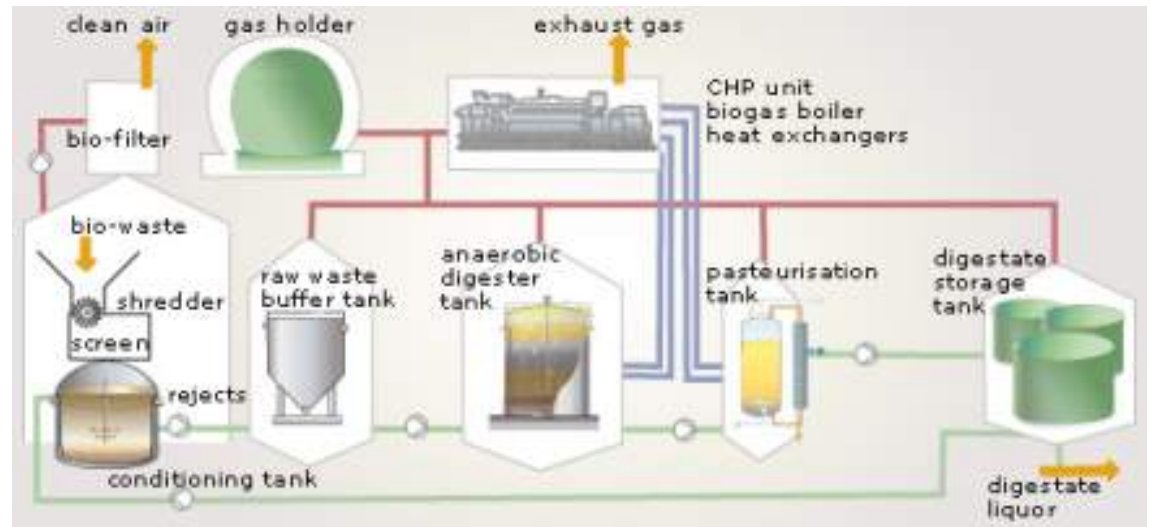

Picture: UK Renewable Energy Association

- Biogas is typically made up of 50-80% methane, 20-50% carbon dioxide, and traces of gases such as hydrogen, carbon monoxide, and nitrogen. In contrast, natural gas is typically made up of more than 70% methane, with most of the rest being other hydrocarbons (such as propane and butane) and only small amounts of carbon dioxide and other contaminants. When the composition of biogas is upgraded to a higher standard of purity, it can be called renewable natural gas
- Upgrading biogas to 95% biomethane is normally performed in two steps, and involves removing other substances from the gas, including carbon dioxide
- The UK produces around 30 million dry tonnes of agricultural manure and food wastes per year, which could, theoretically meet around 16% of transport fuel demand

Source: Energy Savings Trust; www.afdc.energy.gov; www.cleantech.com; SGC; www.nfuonline.com;

Upgraded biogas can be used to fuel natural gas engines, as successfully demonstrated in over 12,000 vehicles worldwide



Picture: Volvo



Picture: Sainsbury's, Clean Air Power



Picture: www.thegreencarwebsite.co.uk

- Upgraded biogas can be used to fuel natural gas engines.
- It 2007 it was estimated that 12,000 vehicles are being fuelled with upgraded biogas worldwide, with 70,000 biogas-fuelled vehicles predicted by 2010. Most of these vehicles are in operation in Europe, with Sweden alone reporting that over half of the gas used in its 11,500 natural gas vehicles is biogas. Germany and Austria have set targets for 20% biogas in CNG by 2020.
- One tonne of LBM is also equivalent to 1,200 litres of diesel, which is sufficient to fuel a 44-tonne heavy goods vehicle for an entire week
- In UK, there are several commercial fleet trials using biogas:
 - Since August 2008, Sainsbury's Supermarkets, has been testing a Mercedes-Benz Axor truck which was retrofitted with dual-fuel technology to run on a combination of biogas and diesel (the "Running on Rubbish" programme). In February 2009 Sainsbury's announced plans today to outfit five more trucks with same hybrid system. The dual-fuel technology was developed by UK-based Clean Air Power. Clean Air Power says its technology allows up to 50% of a vehicle's diesel to be replaced by natural gas or biogas, cutting emissions by about 30% and significantly saving on fuel costs
 - In 2008, Camden Council ran a six-month trial of an Iveco Daily 65C14G cage tipper powered exclusively on LBM, demonstrating a 62% reduction in CO₂

Biogas offers CO₂ benefits on a “well-to-tank” and “tank-to-wheels” basis when compared to conventional diesel



CO₂ Benefit

- Upgraded biogas is considered to be one of the most sustainable biofuels in terms of impact on resource depletion in relation to alternatives such as biodiesel and ethanol.
 - Biomethane has the lowest carbon intensity of all commercially available biofuels
- Recent commercial vehicle trials have suggested a CO₂ saving in excess of 60% compared with an equivalent diesel vehicle.
- There is a further benefit in that the organic waste that is converted into gas would normally be responsible for releasing methane into the atmosphere. Methane has a Global Warming Potential which is 21 times higher than CO₂
 - For example, when liquid manure is used as a feedstock the CO₂ emissions are actually negative (the fuel actually reduces emissions) since if left untreated the manure generates methane emissions
- Equally, care must be taken during the biogas production process to minimise methane leaks, since even a small leak (2%) may negate the CO₂ benefits of using biogas as a road fuel instead of diesel



The initial cost for a biogas vehicle is high, but this could be paid back in fuel savings

Technology and Environmental Cost

Technology

- It is expected that the capital cost for a biogas vehicle will be more than with a conventionally fuelled vehicle. For example, new biogas heavy goods vehicles could be around £25,000 to £35,000 more expensive, whilst new biogas vans cost approximately £4,000 to £5,000 more.
 - There may also be issues with increased maintenance costs
- Biogas can be produced in the UK at a cost of between 50-60p/kg (including duty but not VAT). This is comparable with the price of compressed natural gas at around 55p/kg
- Upgrading biogas is the most important cost factor in producing a biogas road fuel

Environmental

- Recent commercial vehicle trials have suggested NOx emissions are lower and, with little or no particulate emissions
 - These low exhaust emissions means biogas can help to improve local air quality
- Sanitisation of some materials, such as meat-containing wastes from foodstuff, slaughterhouse waste and catering waste, is required prior to biogas production in order to reduce the risk for human and animal health



Picture: SGC

Technology Cost



Environmental Cost



If UK follows the example of Sweden, then biogas could become a small, but significant, part of the national fuel mix

Safety and Limitations

- ✓ In upgraded form, biogas can be used in any natural gas engine
- ✓ Biogas has been used safely to power vehicles in fleet trials
- ✗ Like CNG, if biogas is to be used as an alternative fuel for HGVs, then a national biogas refuelling infrastructure needs to be built
- ✗ Sanitisation of some feedstock is required prior to biogas production in order to reduce the risk for human and animal health
- ✗ Biogas leaks can cause explosions and fire

Technology Maturity

- Currently in UK, the supply of biogas for road transport use is limited to a small number of trials; there are no public refuelling outlets
 - However, several refuelling stations linked to the HGV industry are planned for the next 5 years
- In Sweden and Switzerland pure biogas is available at a transport fuel
- Sweden has the largest fleet of biogas-fuelled vehicles in the world, with around 7,000 vehicles in the country and plans to increase this number to 80,000 by 2010. With over 10 years experience in using biogas as a vehicle fuel, Sweden has built up a network of gas refuelling stations, with over half the gas supplied being biogas. By 2020 the Swedish use of methane in the automotive sector could reach 5% via biogas and another 10% via natural gas
- Germany opened its first biogas refuelling station in 2006. Both Germany and Austria have set targets for 20% biogas in CNG by 2020.

Safety and Limitations



Maturity

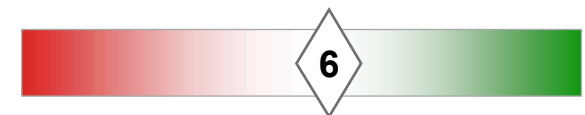



Hydrogen can be used to fuel vehicles, but this also requires the development of a national hydrogen refuelling infrastructure

Hydrogen

- Concept:** A spark-ignition internal combustion engine run on hydrogen to reduce engine-out emissions
- Base Functioning:** A gas engine can be converted to run on hydrogen with minor modifications
- CO₂ Benefit:** Running an engine on hydrogen produces negligible CO₂ emissions, however the WTW benefit depends on the energy source and method used to produce the hydrogen
- Costs:** It is expected that a H₂-ICE would be priced similar to a gas ICE. However costs of the on-board hydrogen storage tank would be significantly higher since the hydrogen would need to be stored at a higher pressure (350-700 bar)

Safety and Limitations

-  Numerous demonstration projects have shown the hydrogen can safely be used to fuel vehicles
-  The current lack of infrastructure for refuelling hydrogen vehicles limits the uptake and use of H₂-ICE technology

Technology Applicability

- No OEMs are currently considering developing H₂-ICEs for HVGs
- However, over the past decade there have been numerous high profile fleet trials of H₂-ICE buses (e.g. HyFLEET:CUTE project)

Fuel Technology

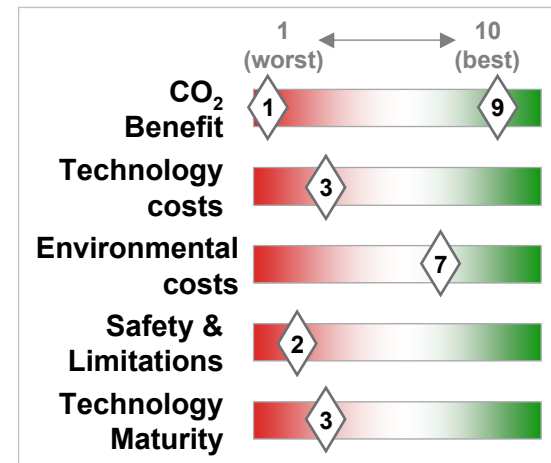

Visualisation



Picture: PLANET

Hydrogen is often seen as the Energy Vector of the future since it can be produced from a range of energy sources



Technology Description

Hydrogen as an Energy Vector

- Hydrogen is the most abundant and lightest chemical element (1.00794 g/mol). At room temperature, hydrogen is a colourless, odourless gas
- Hydrogen has high energy content per weight (nearly 3 times as much as gasoline), but the energy density per volume is low at standard temperature and pressure, so it needs to be stored under pressure or as a cryogenic liquid
- Hydrogen only requires a small amount of energy to ignite. It has a wide flammability range, meaning it can burn when it makes up 4-74% of the air by volume. It burns with a pale-blue, almost-invisible flame
- Hydrogen readily combines with oxygen to produce water. Combustion of hydrogen does not produce CO₂, particulate or sulphur emissions. However NO_x emissions can be produced under some conditions
- Since elemental hydrogen is rare on earth, it needs to be produced. Therefore, hydrogen is considered to be an **energy vector**, not an energy source
- Hydrogen can be produced from a variety of primary energy sources by various processes. Today, the two most popular means of producing hydrogen are by steam methane reforming (SMR) of natural gas and by electrolysis

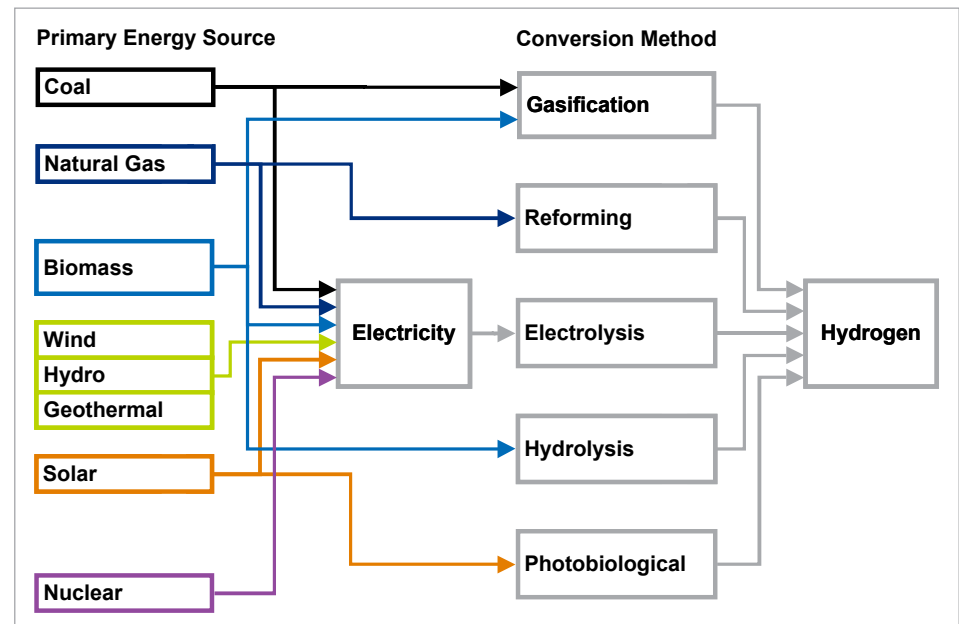

Some of the energy sources and processes that can be used to produce hydrogen

- Many industrial processes require hydrogen as an ingredient, or produce hydrogen as a by-product. The total hydrogen consumption in Western Europe is estimated to be about 61bn m³ (2003), 80% of which was consumed by mainly two industrial sectors: the refinery (50%) and the ammonia industry (32%)

Hydrogen can be used to power a spark-ignition internal combustion engine



Hydrogen Internal Combustion Engines

- The design and operation of hydrogen ICEs is typically based on CNG ICEs, requiring a spark to ignite the fuel mixture
- Several OEMs have conducted research into H₂-ICEs - such as BMW, Daimler (ended research in 1997) Ford and MAN – although these engines tended to be for passenger cars or buses, not for HGVs
- MAN have produced several H₂-ICE buses for various hydrogen demonstration programmes since the early 1990s. Between 2006 to 2008 they provided 14 H₂-ICE buses for the HyFLEET:CUTE project. The buses contains in-line six cylinder engines capable of 150 kW (naturally aspirated) to 200kW (with turbo charger). For the 150 kW NA H₂-ICE, maximum torque was 760 Nm. An exhaust gas aftertreatment system with NOx reduction catalyst was fitted to reduce the tailpipe NOx emissions to ~0.2 g/kWh
- ISE and Ford have developed a hybrid hydrogen ICE bus which is in service in the Palm Springs area of California, USA
- Ford has demonstrated up to 30 vans using their H₂-ICE. These vans are in operation in Canada and USA
- In USA there have been several studies involving mixing hydrogen and CNG (HCNG) for use in gas ICEs
- In March 2008, the UK Post Office began trials of two H₂-ICE powered delivery vans

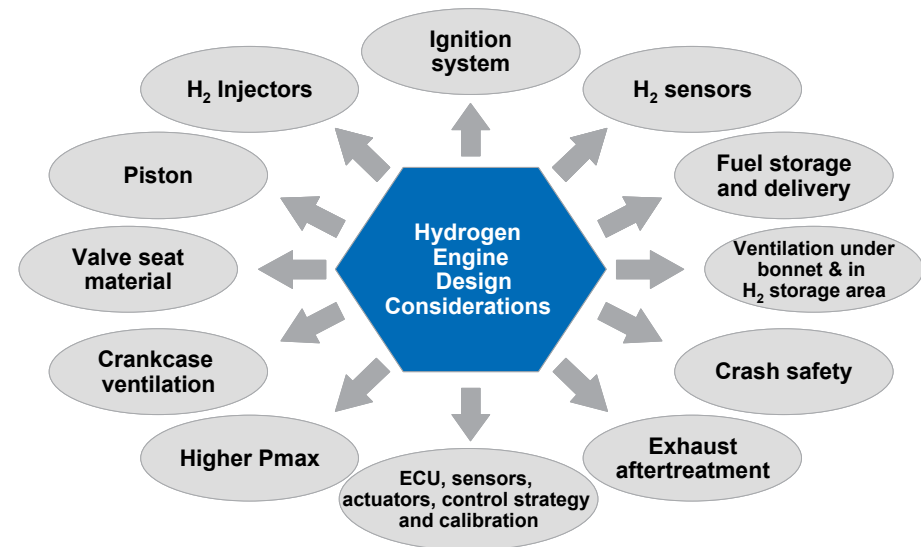

Picture: MAN hydrogen ICE H 2876 UH01 with 150 kW, from HyFLEET:CUTE website

The main challenges for hydrogen fuelled spark ignition ICEs are uncontrolled ignition, NOx emissions and achieving performance

Challenges

Pre-ignition

- Auto ignition in the combustion chamber before spark
- Limits rich lambda range and therefore limits torque output
- So far, only BMW have successfully run H₂-ICEs stoichiometrically

Inlet manifold backfire

- Auto ignition in the inlet manifold

NOx Emissions

- NOx is the main emission from H₂-ICEs
- NOx formation is dependent on combustion temperature
 - Which depends on AFR

Low specific power and torque

- Port injection, natural aspiration H₂-ICEs produce less power and torque than conventional gasoline engines
 - H₂ displaces air, reducing the calorific value of the mixture
 - Abnormal combustion near stoichiometric

Control Measures

- Improved combustion chamber cooling (particularly exhaust valves)
- Dual VVT with calibration for reduced trapped residuals
- Improved oil control
- Low hydrogen injection temperature (possible if liquid H₂ stored on board)
- Direct injection will give least risk of backfire
- Otherwise, careful control of inlet and exhaust valves limits the risk of backfire
- Run as lean as possible; Apply EGR
- Lower hydrogen injection temperature
- Optimise cooling strategies
- If DI, optimise injection timing to reduce NOx
- NOx aftertreatment system
 - Lean operation at high load requires LNT
 - TWC possible if stoichiometric operation achieved
- Boosting
- Direct Injection
- Measures to allow stoichiometric operation

One of the main issues with using hydrogen as a fuel is storing it on-board the vehicle



Hydrogen as an Additive

- Hydrogen can be added to the intake air of a diesel engine, with the aim of improving the combustion characteristics
 - Research by Ricardo found that the addition of syngas from an on-board fuel reforming had some potential to lower soot, but this depended on the engine calibration
- Hydrogen can be injected into the exhaust stream to increase temperatures for regeneration of the DPF and LNT aftertreatment systems

Hydrogen On-board Storage

- If hydrogen is to be used as the primary energy vector, then the vehicle must be able to store the hydrogen on-board, or have an efficient on-board fuel reformer
- Hydrogen can be stored as a compressed gas, cryogenic liquid or in a metal hydride. Compressed gas at 350-700 bar is the most likely form of hydrogen storage to be used for large vehicles such as buses and HGVs
- The HyFLEET:CUTE H₂-ICE buses, provided by MAN, had 10 pressure cylinders with 50kg of H₂ at 350 bar, and were capable of a driving range of approximately 220 km. The hydrogen cylinders tended to be located on top of the vehicle

Depending on the energy source and production method, hydrogen can either significantly reduce GHG emissions, or be even worse

CO₂ Benefit

Hydrogen Production

- The Source-to-Tank CO₂ emissions for hydrogen depends on the primary energy source and production method. Values range from ~0 kgCO₂/GJ for renewable methods to > 300 kgCO₂/GJ for coal
- Hydrogen can be produced from a number of CO₂-neutral sources, such as renewable electricity, biomass, nuclear power, and fossil fuels with CCS. However many of these sources can also be used to de-carbonise the supply of electricity, while others are at an early stage of R&D
 - A study by the Roads2HyCom project found that many of these CO₂-neutral sources are unlikely to be favoured until after 2030
- In the short to medium term, it is likely the hydrogen for transport would be produced by steam methane reforming on natural gas, which would produce ~7.5 kgCO₂/GJ

Hydrogen ICE

- H₂-ICEs produce negligible tailpipe CO₂ emissions (from the combustion of the lubricating oil)

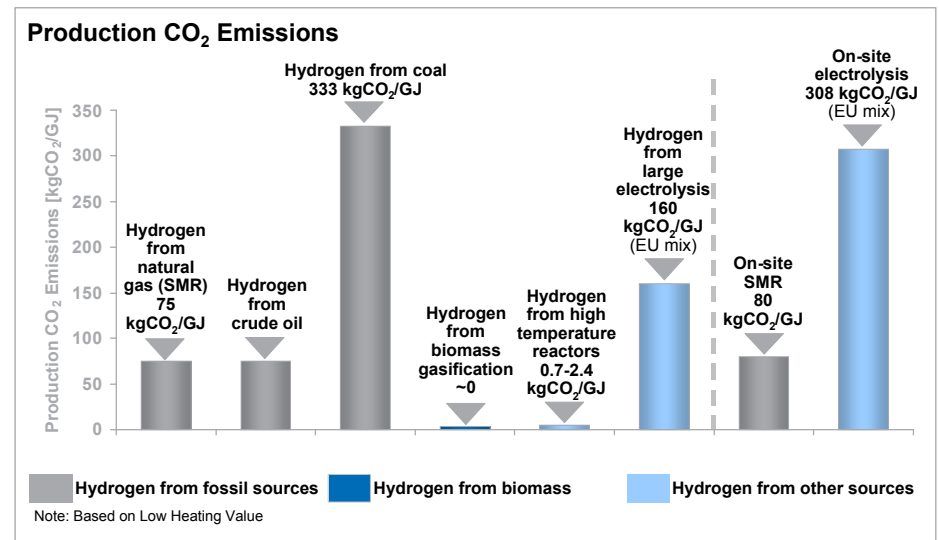

Picture: Roads2HyCom (IFP)



The energy source and production method also determine hydrogen's technology cost ...

Technology Cost

- The cost of producing hydrogen depends on the primary energy source (feedstock), production process and scale of plant
 - Analysis from the Roads2HyCom project shows that future hydrogen may be more expensive than gasoline even at \$135/barrel
- In addition to the cost of producing hydrogen, the cost of developing a national network of hydrogen refuelling stations also needs to be considered, if hydrogen is to be used as the main on-board energy vector
- The cost of a H₂-ICE is likely to be comparable to the cost of a gas ICE
- However, the cost of a hydrogen on-board storage tank is significantly more than the cost of a conventional liquid storage tank, since the hydrogen must be storage as either a compressed gas (350-700 bar) or as a cryogenic liquid

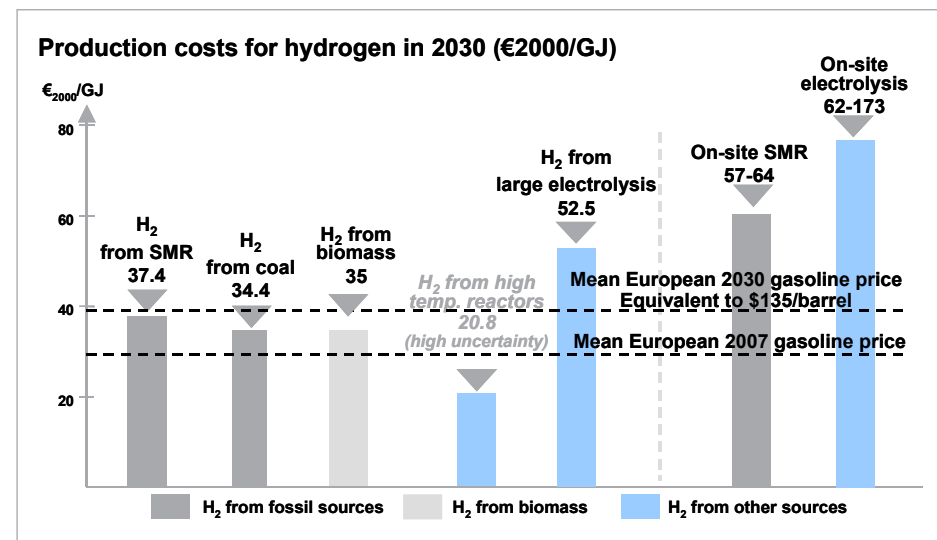

Picture: Roads2HyCom (IFP)

Technology Cost

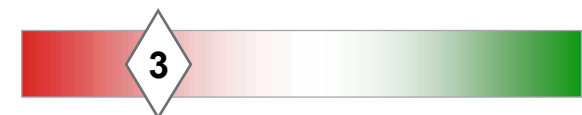

... and life cycle environmental impact



Environmental Cost

Hydrogen Production

- The environmental cost of producing hydrogen depends on the primary energy source and production method

Hydrogen ICE

- Although most emissions from a H₂-ICE are nearly negligible, the engine will produce NO_x under certain operating conditions
 - The HyFLEET:CUTE MAN H₂-ICE engine fitted with a NO_x aftertreatment system. Tailpipe emissions were NO_x ~0.2 g/kWh; HC 0.04 g/kWh and PM <0.005 g/kWh

Hydrogen On-Board Storage Tank

- The construction of compressed hydrogen storage tanks is time and energy intensive, requiring the use of materials such as carbon fibre

Environmental Cost

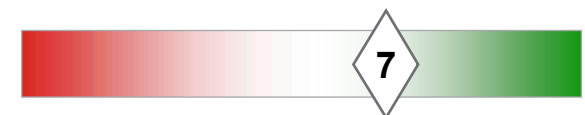

Although Hydrogen has shown to be safely used as an automotive fuel safety issues and lack of infrastructure limits uptake



Safety and Limitations

- ✓ Numerous demonstration projects have shown the hydrogen can safely be used to fuel vehicles
- ✗ Staff training would be required to ensure safe handling of the hydrogen fuel
- ✗ Training is also required for fire fighters in how to deal with this “new” fuel
- ✗ The current lack of infrastructure for refuelling hydrogen vehicles limits the uptake and use of H₂-ICE technology

Technology Maturity

- The industrial processes for producing hydrogen (SMR, electrolysis, etc.) are well known and established
- Several OEMs have conducted research in the area of H₂-ICE, however the applications tend to be passenger cars and buses, not HGVs
 - Passenger cars: BMW, Ford, Mazda
 - Buses: Daimler (ended H₂-ICE research in 1997), Ford, MAN
- There have been several high profile fleet demonstrations of H₂-ICE powered buses, such as the HyFLEET:CUTE project
- Given the higher costs and increases in weight due to the hydrogen storage tanks, and given the lack of hydrogen refuelling infrastructure, it is likely that hydrogen will not be used to fuel HGVs in the short or medium term

Safety and Limitations



Maturity

